



45824

MASTER
PIECE



 **WARNING: CHOKING HAZARD.** Toy contains small parts and a small ball. Not for children under 3 years.

1

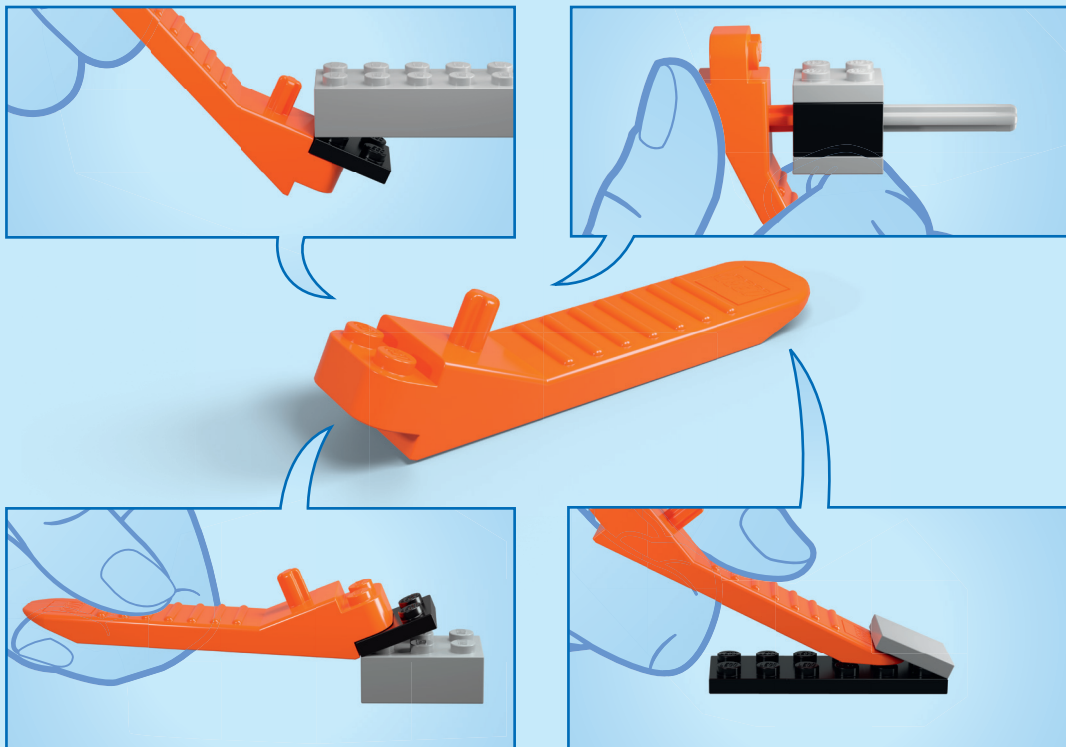

- ⚠ **AVERTISSEMENT : RISQUE D'ÉTOUFFEMENT.**
 Le jouet contient des petites pièces ainsi qu'une petite boule.
 Il ne convient pas aux enfants de moins de 3 ans.
- ⚠ **ADVERTENCIA: PELIGRO DE ASFIXIA.**
 Juguete que contiene partes pequeñas y una pelota pequeña.
 No recomendado para niños menores de 3 años.

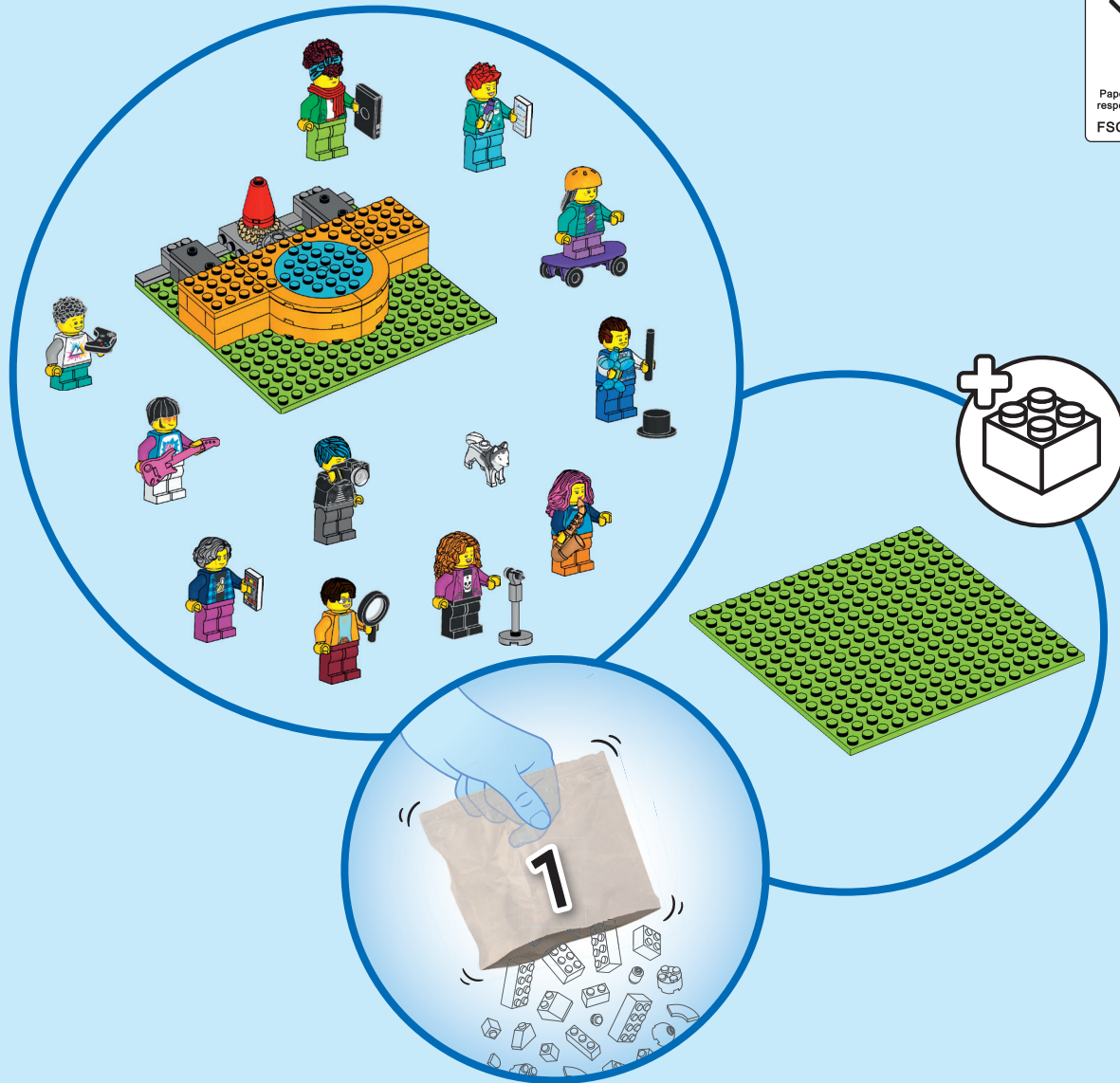

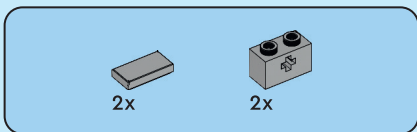
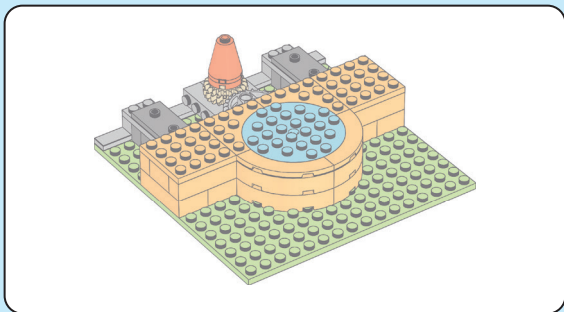

1

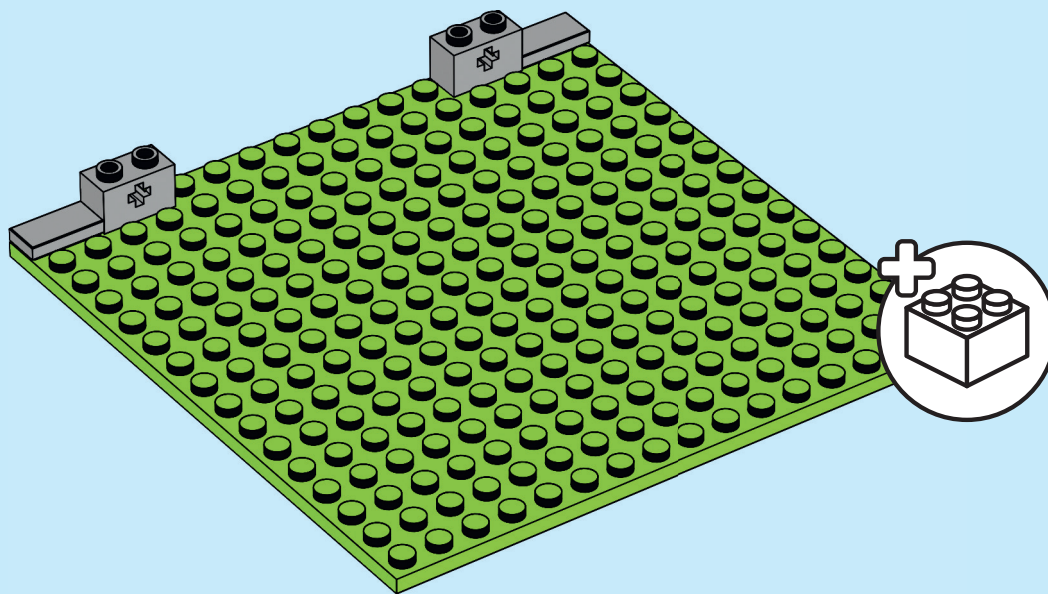

4

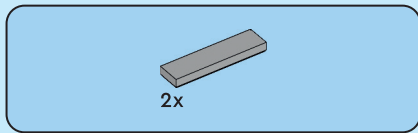

2

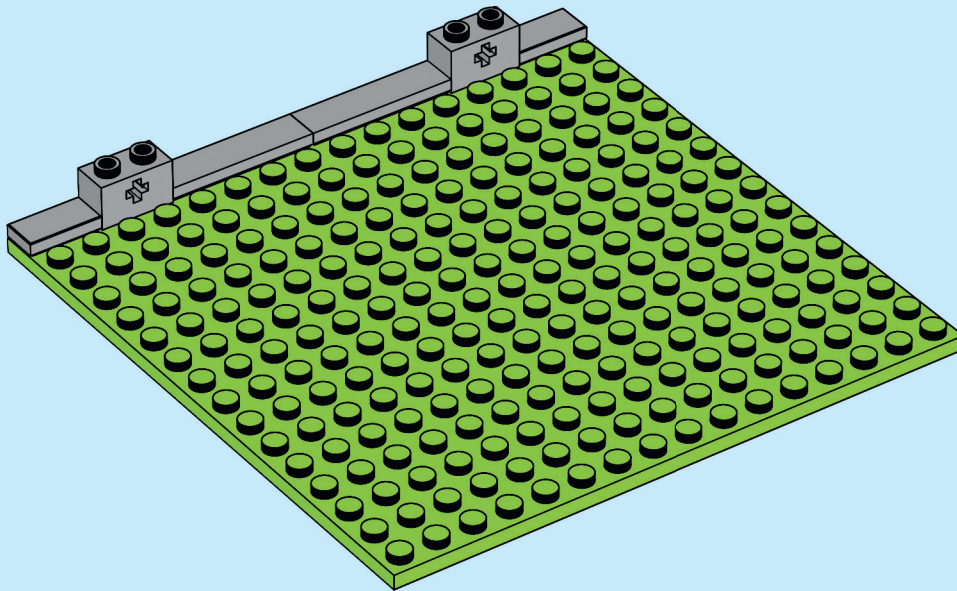

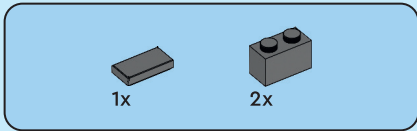

3

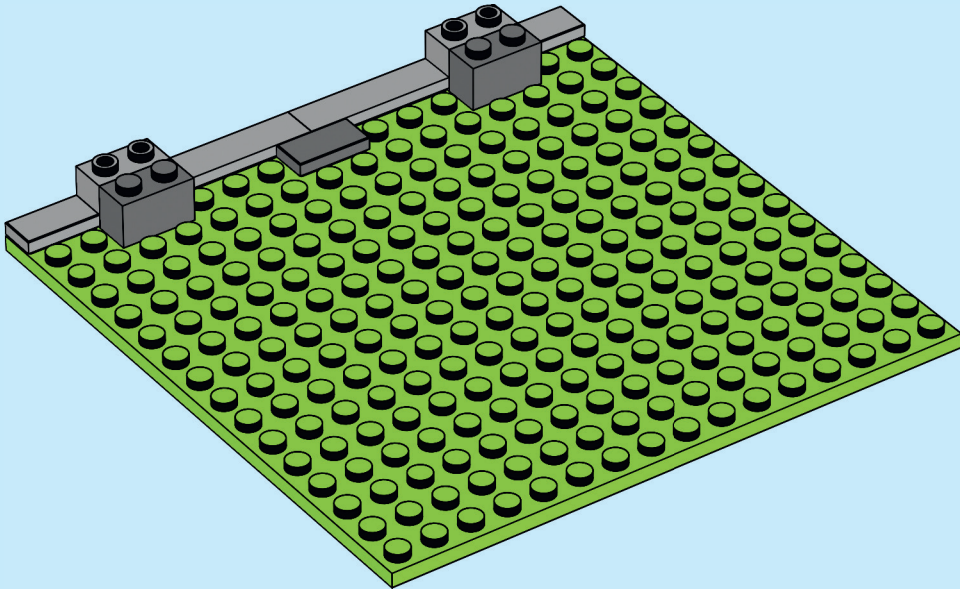

6

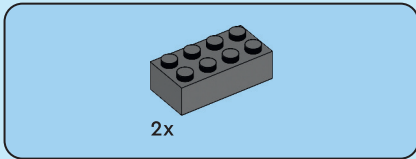

4

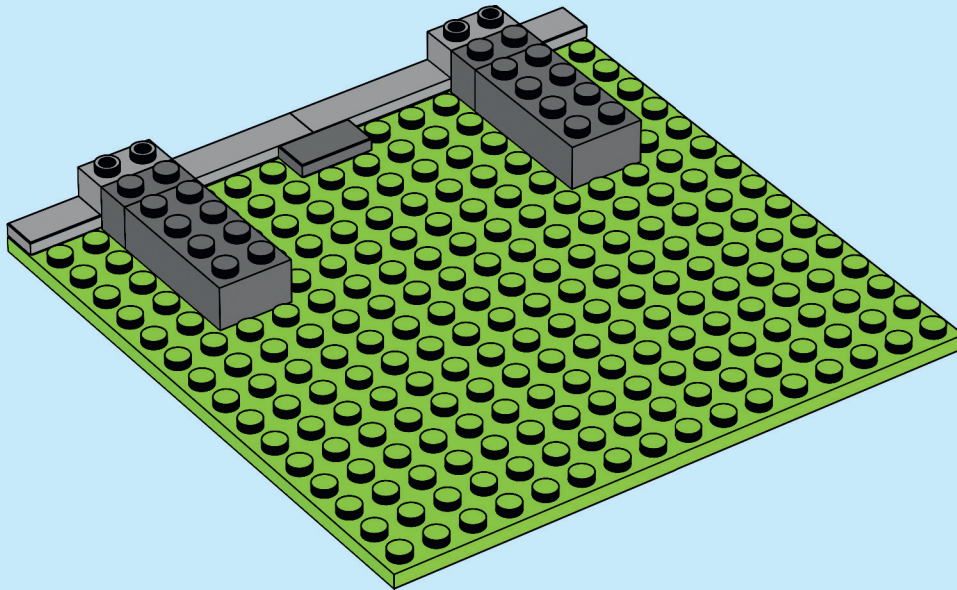

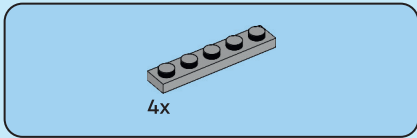

5

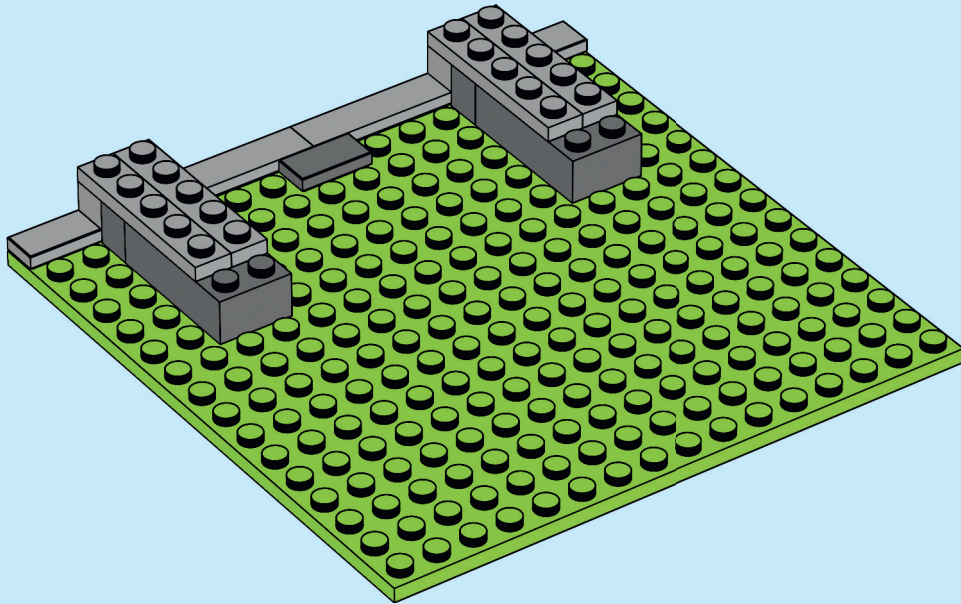

8

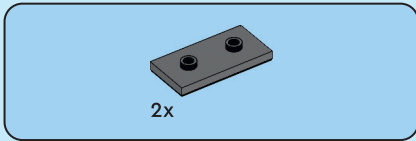

6

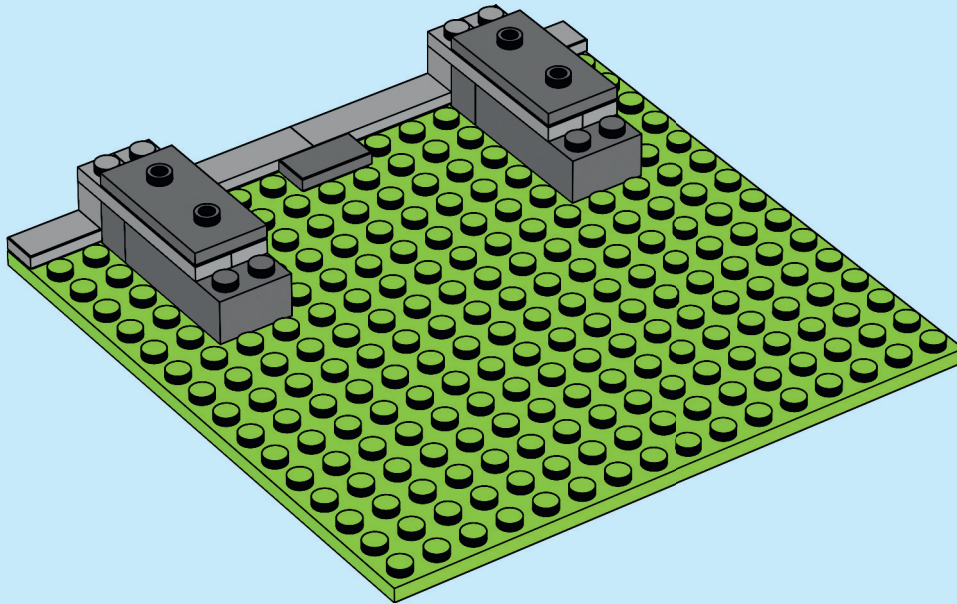

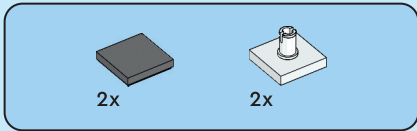

7

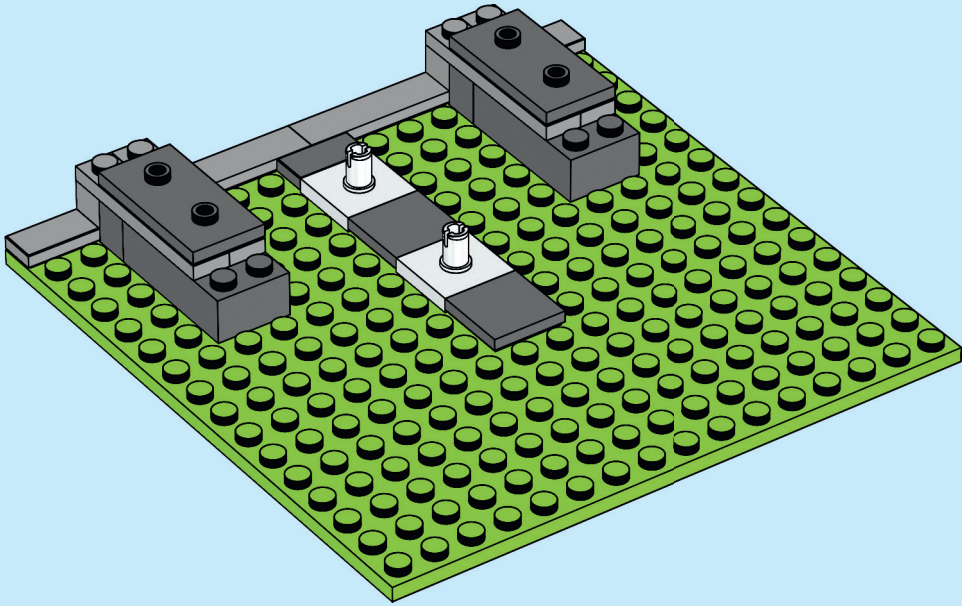

10

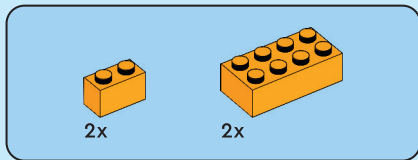

8

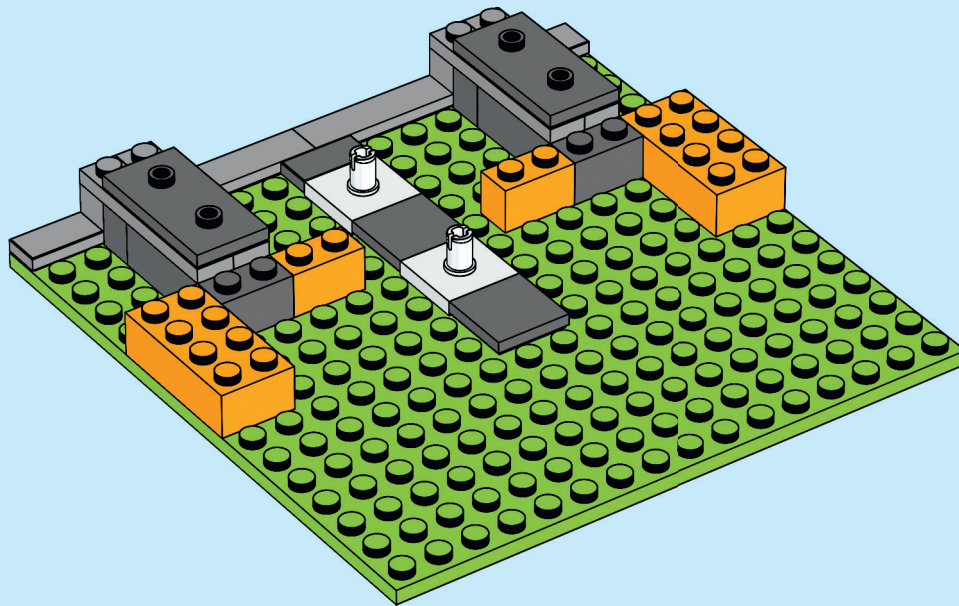

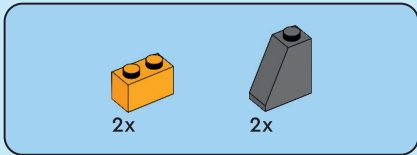

9

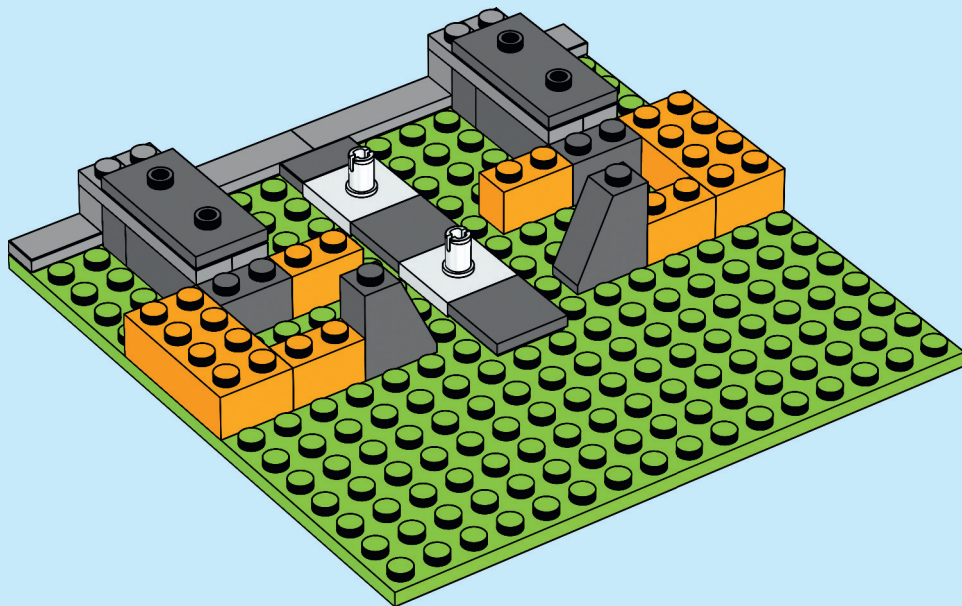

12

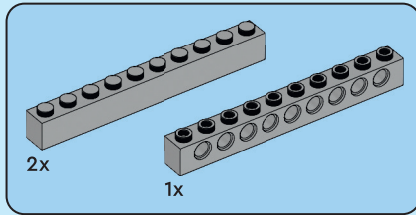

10

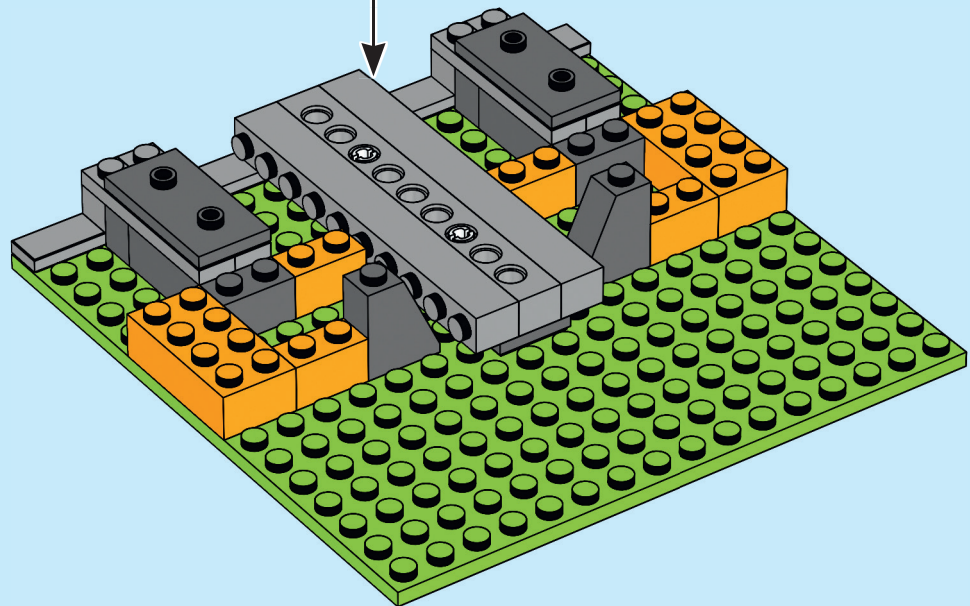
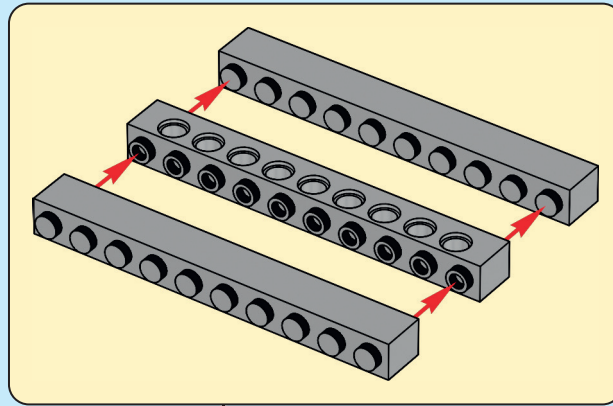

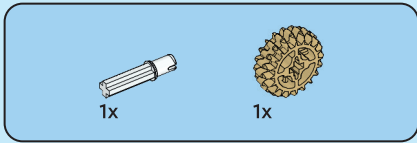

11

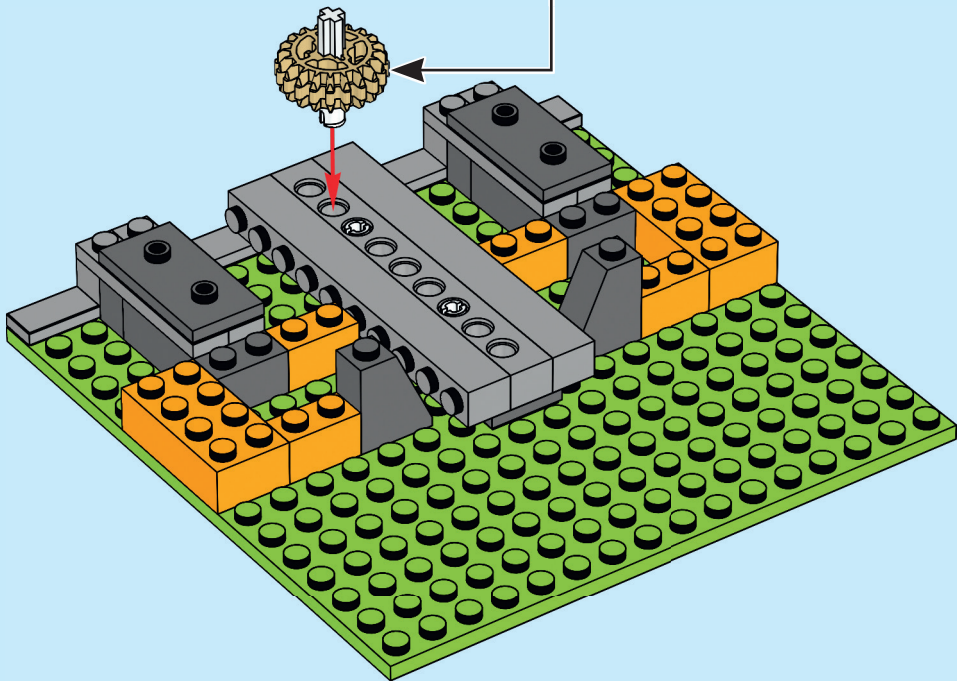
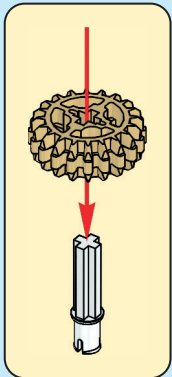

14

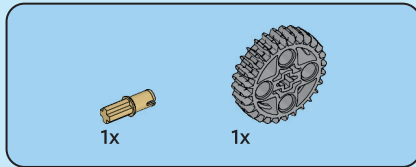

12

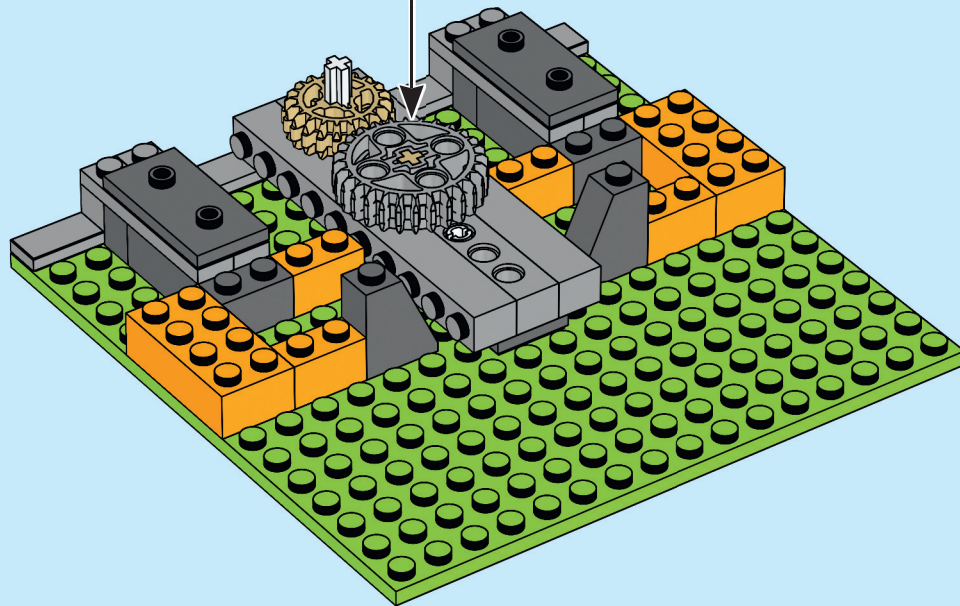
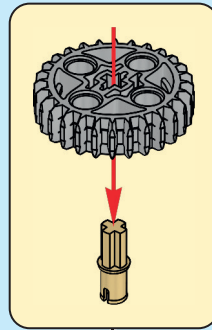

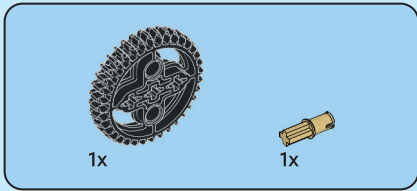

13

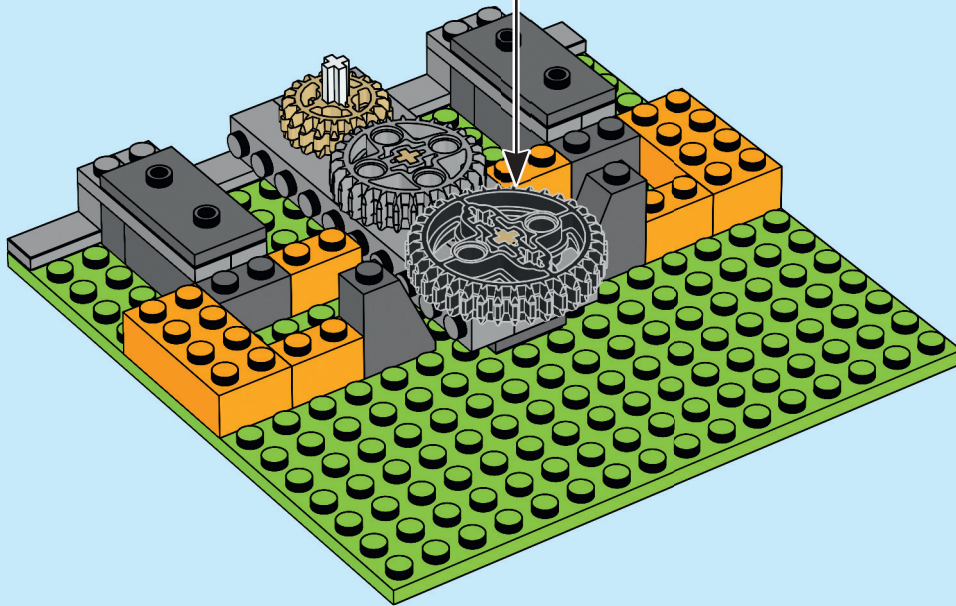
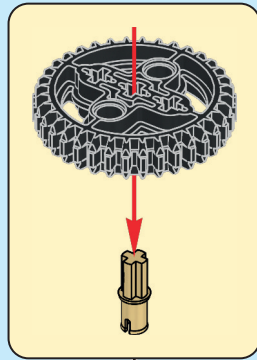

16



14

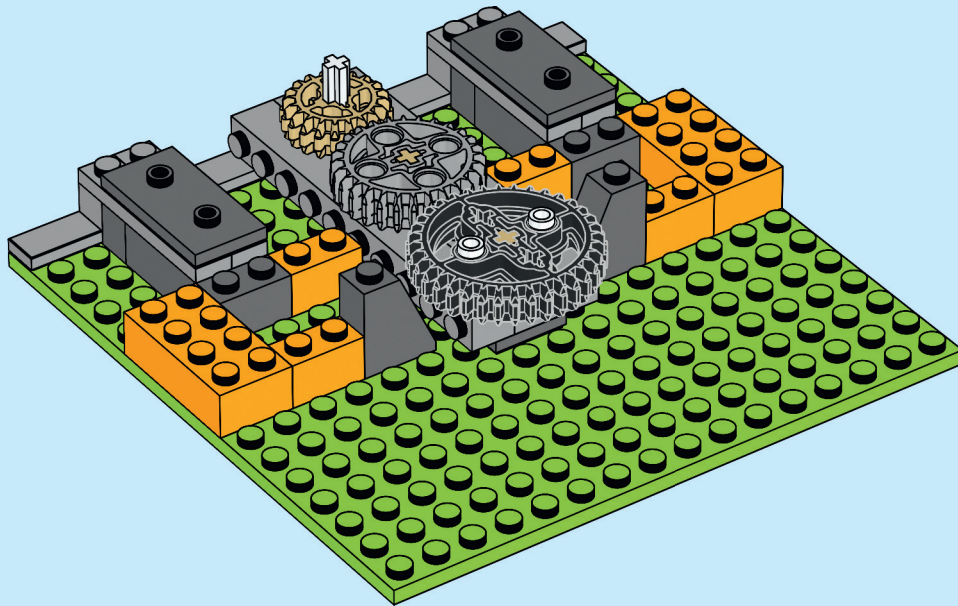

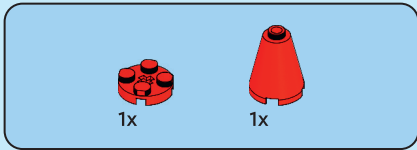

15

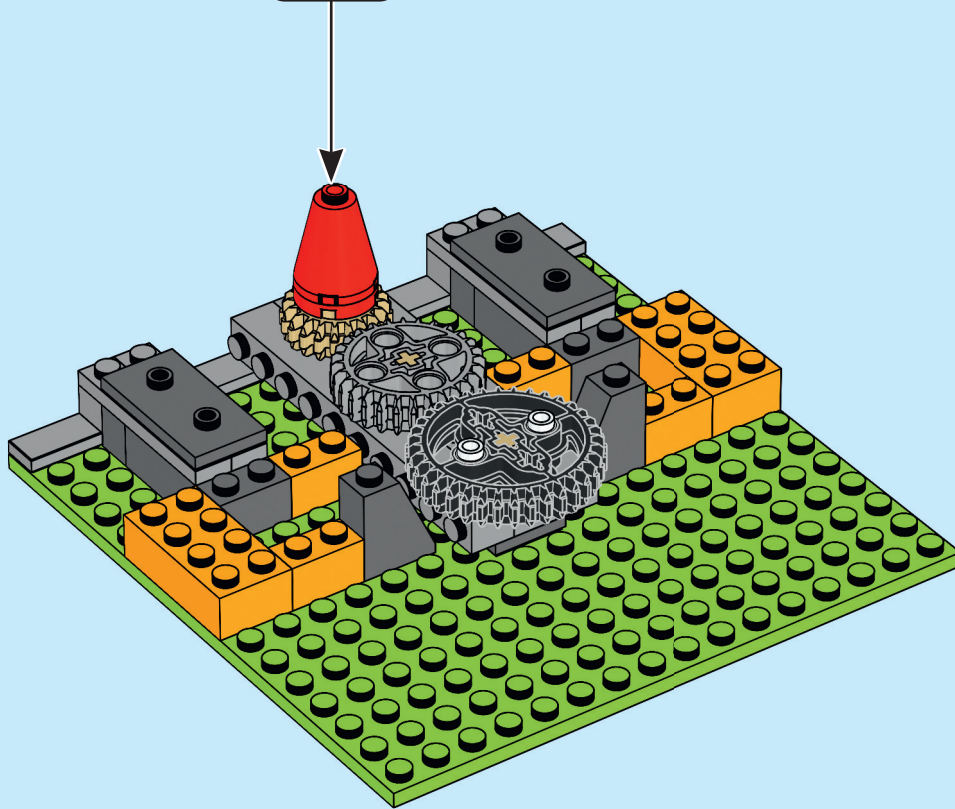
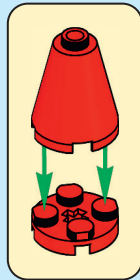

18

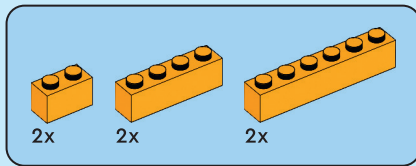

16

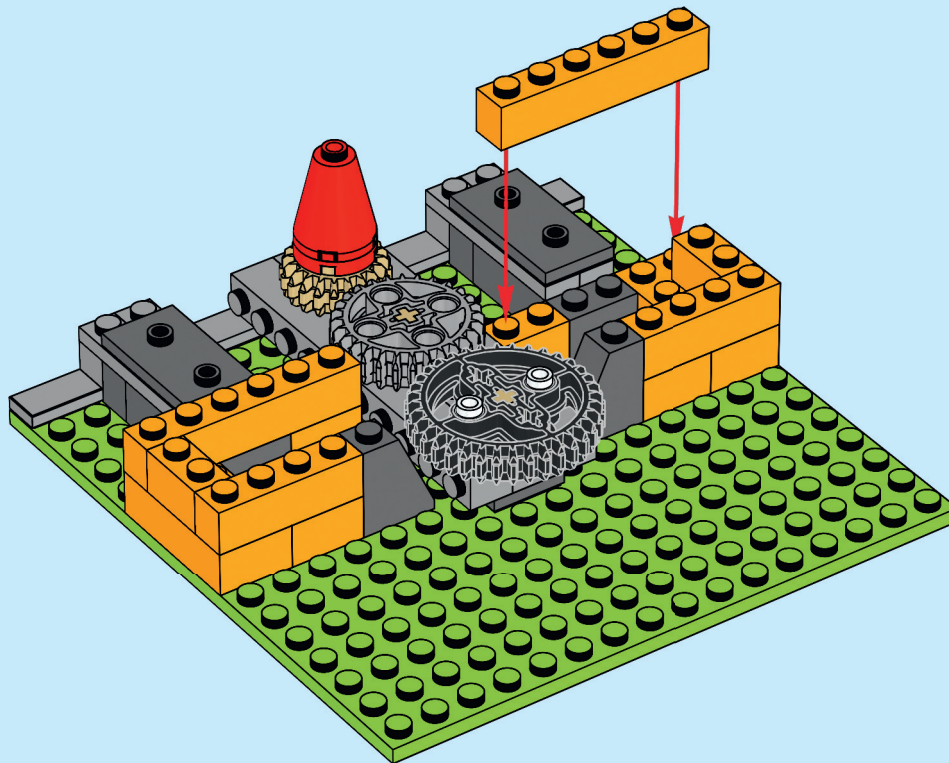

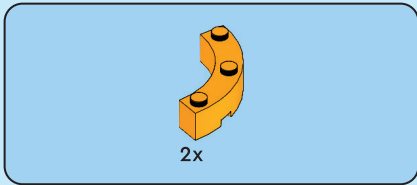

17

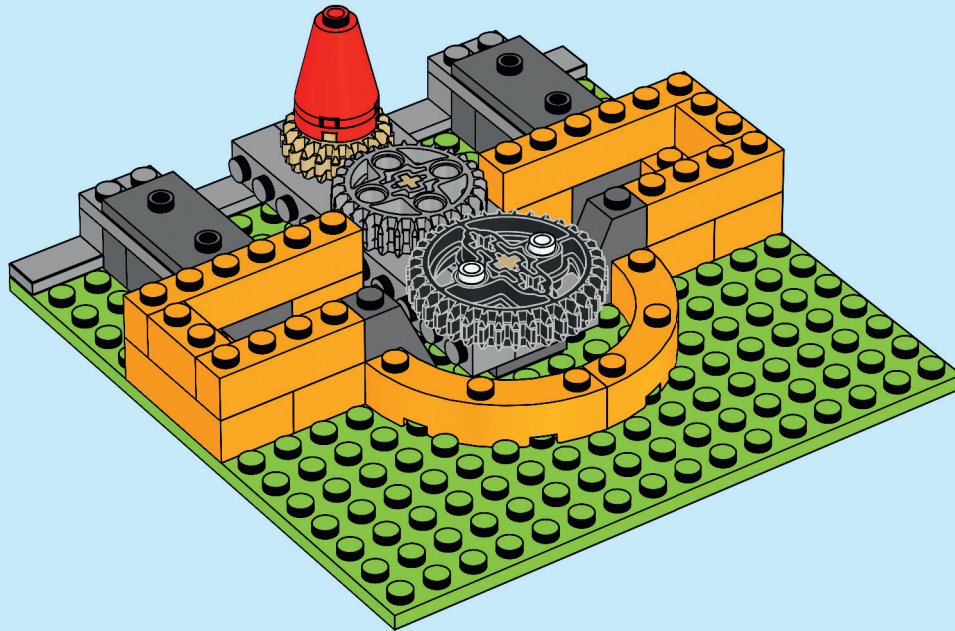

20

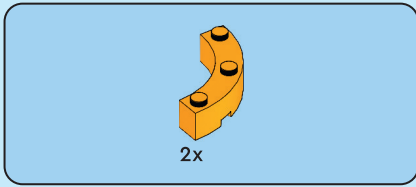

18

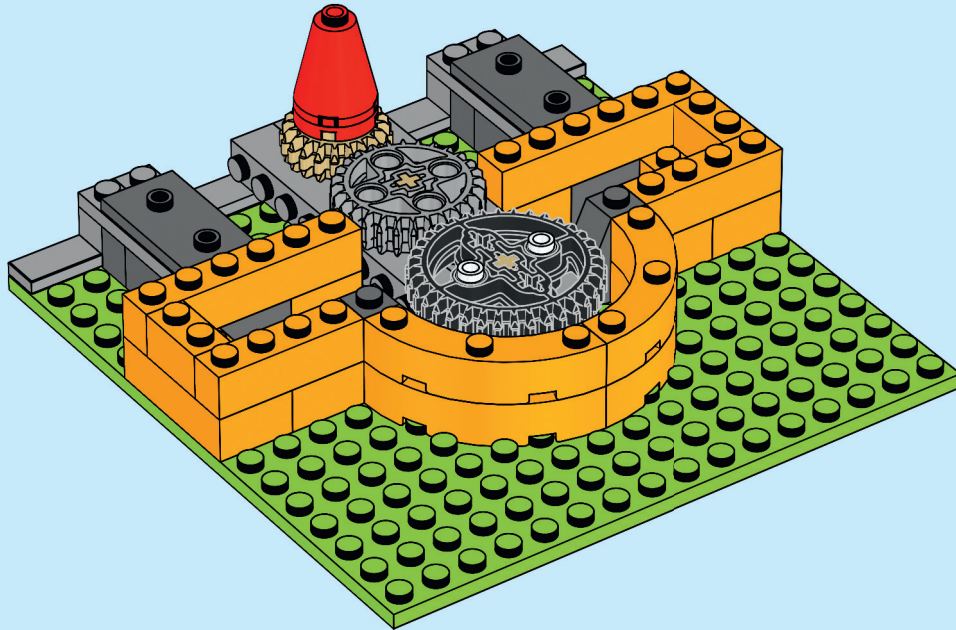



2x

19

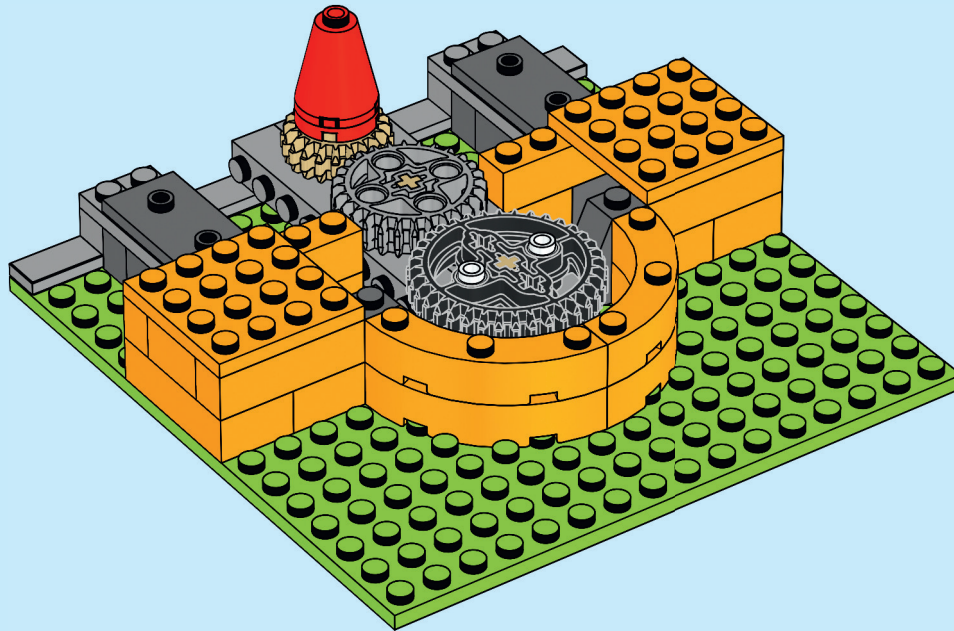

22



2x

20

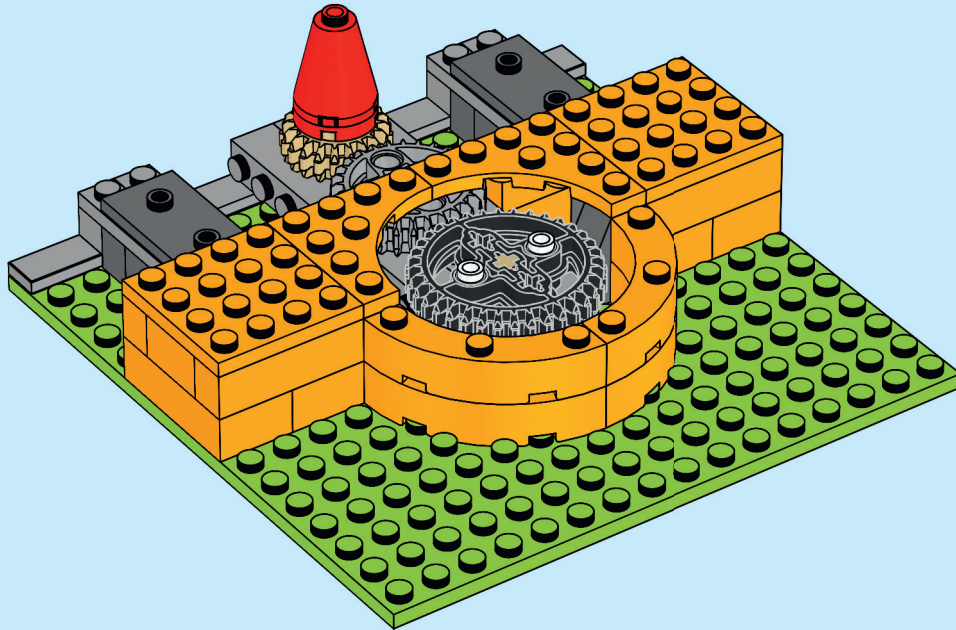

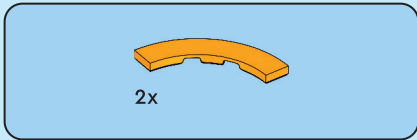

21

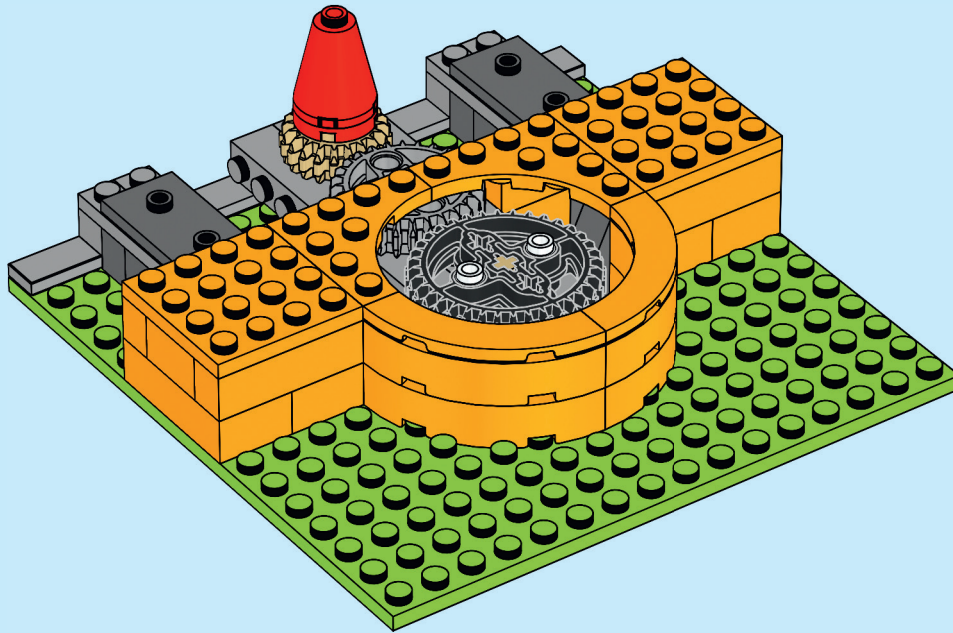

24

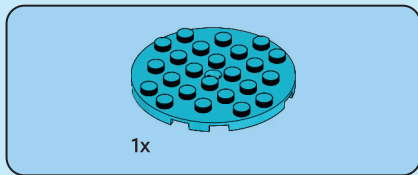

22

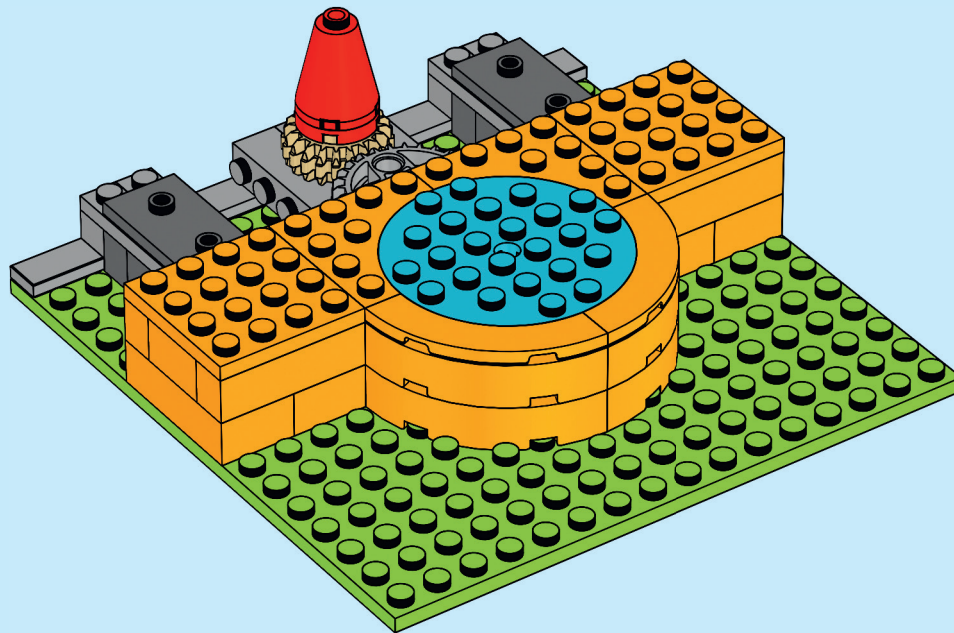

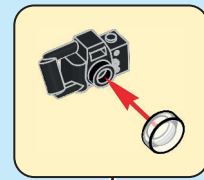
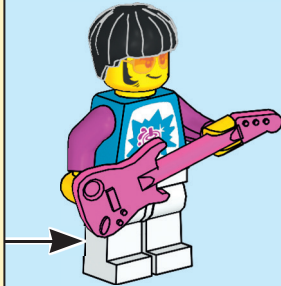
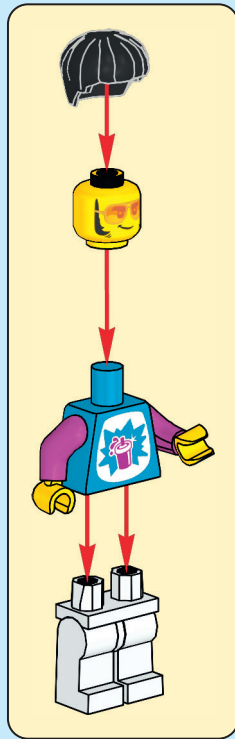

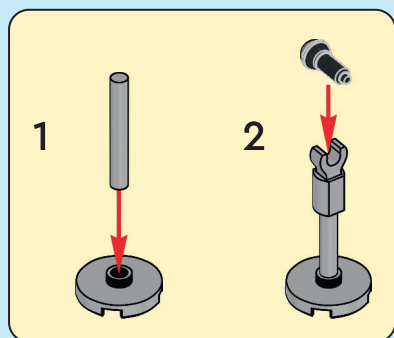

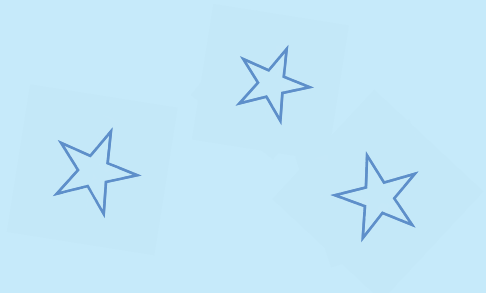

1

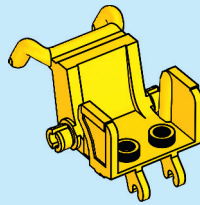

2

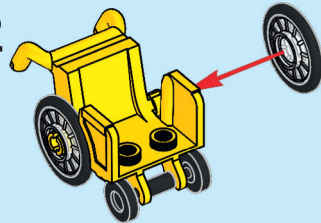



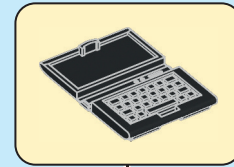
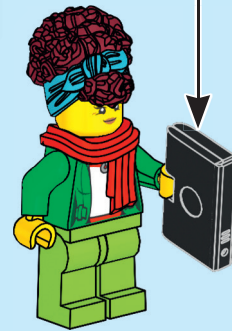
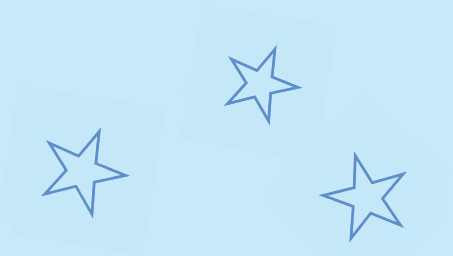



LEGO and the LEGO logo are trademarks of the/sont des marques de commerce du/son marcas registradas de LEGO Group.
©2023 The LEGO Group. 6469130

FIRST® is a registered trademark of For Inspiration and Recognition of Science and Technology (*FIRST*). LEGO® is a registered trademark of the LEGO Group.
FIRST® LEGO® League and MASTERPIECESM are jointly held trademarks of *FIRST* and the LEGO Group.

©2023 *FIRST* and the LEGO Group. All rights reserved.