

45824

MASTER
PIECE

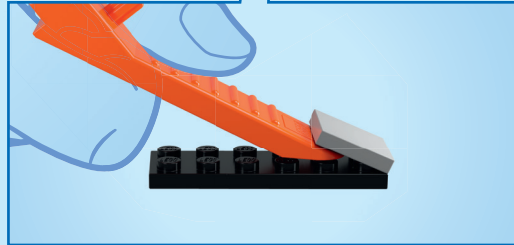

1

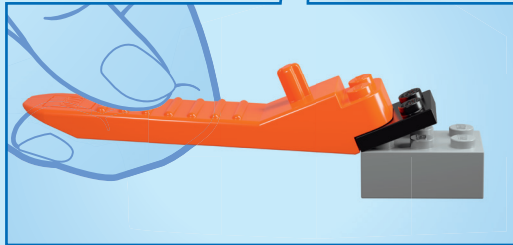
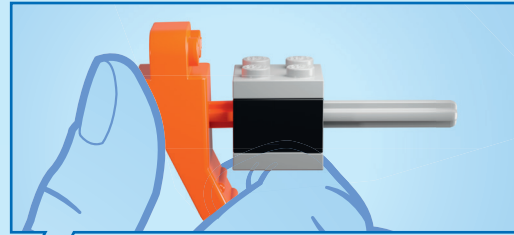
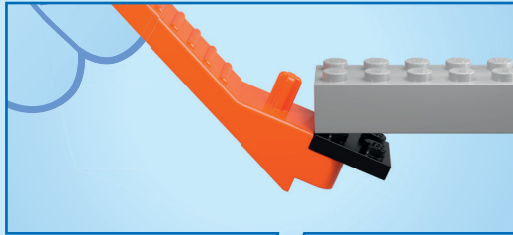

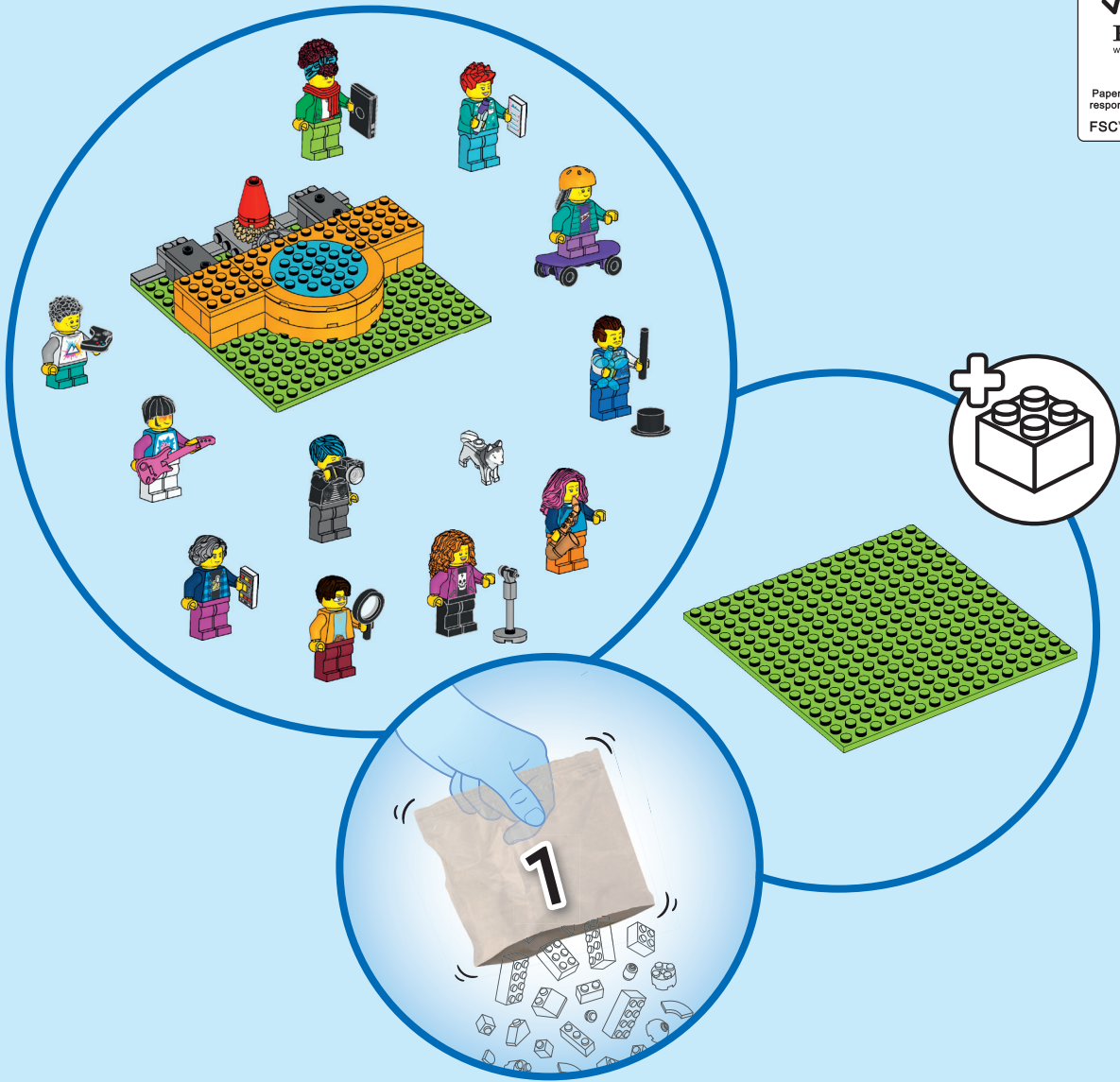

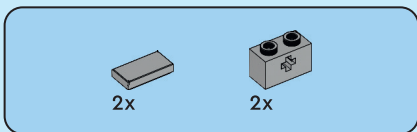
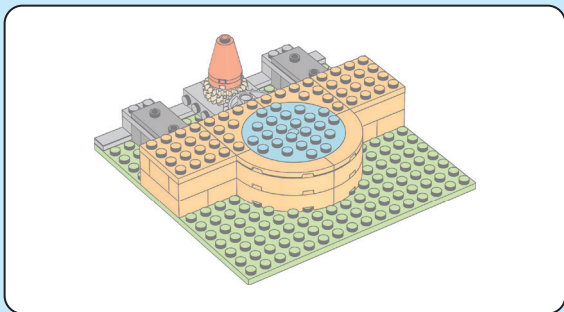

1

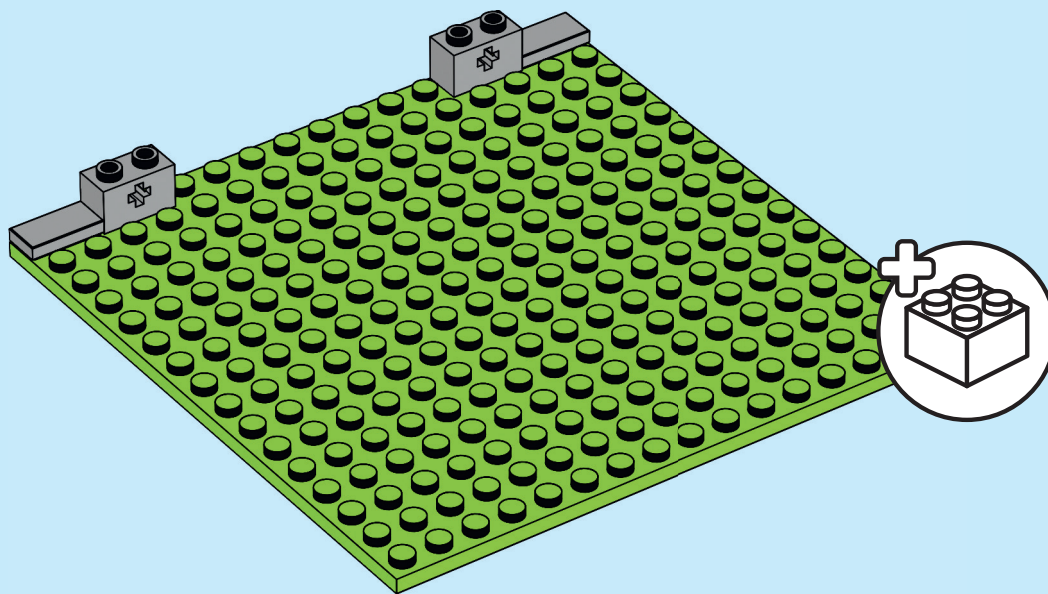

4

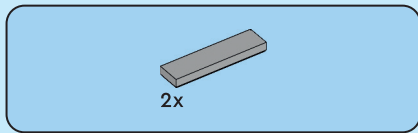

2

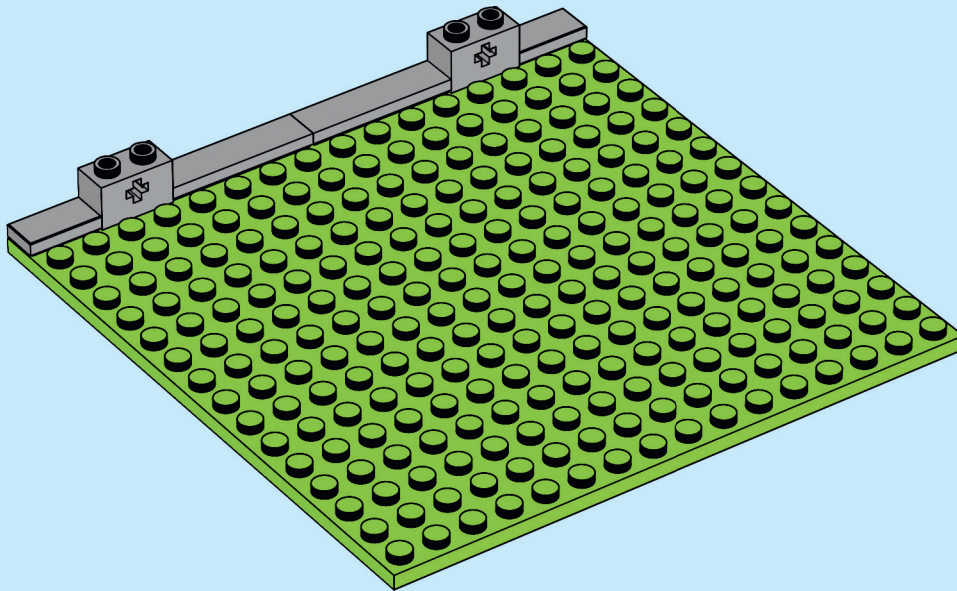

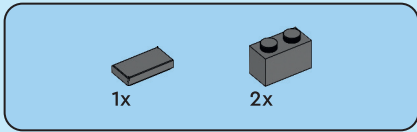

3

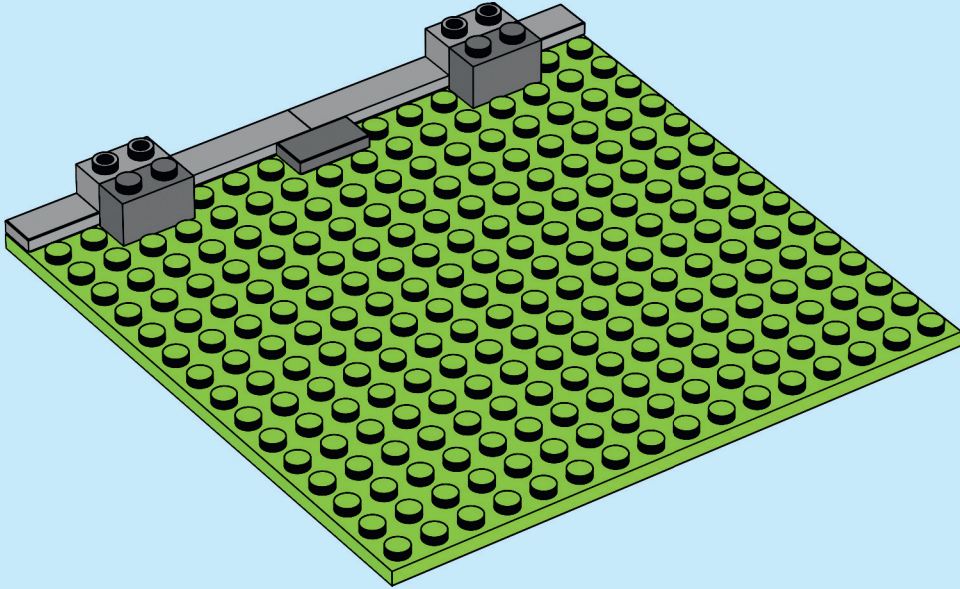

6

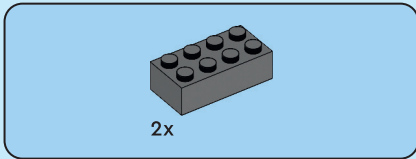

4

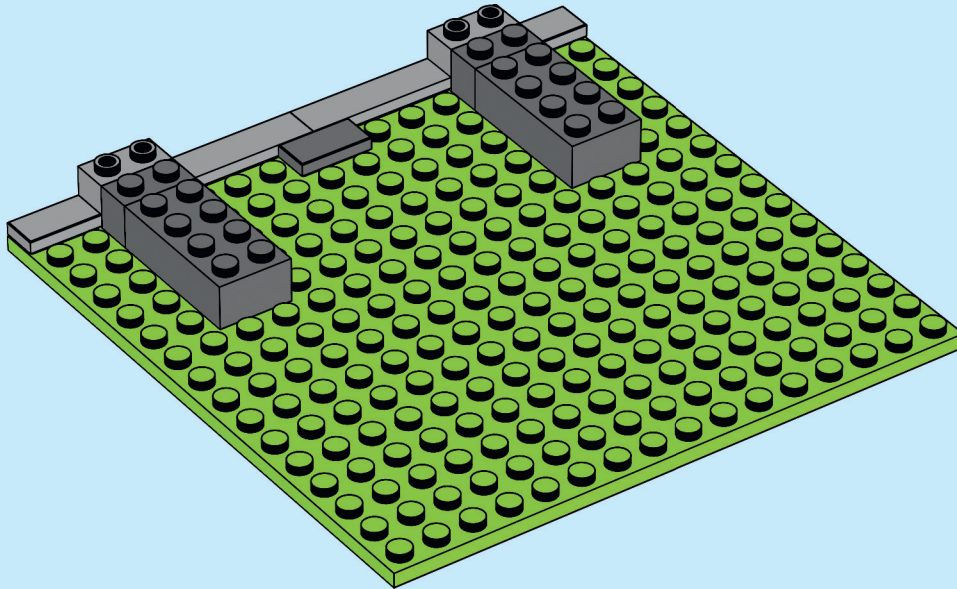

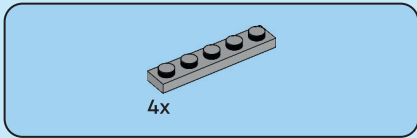

5

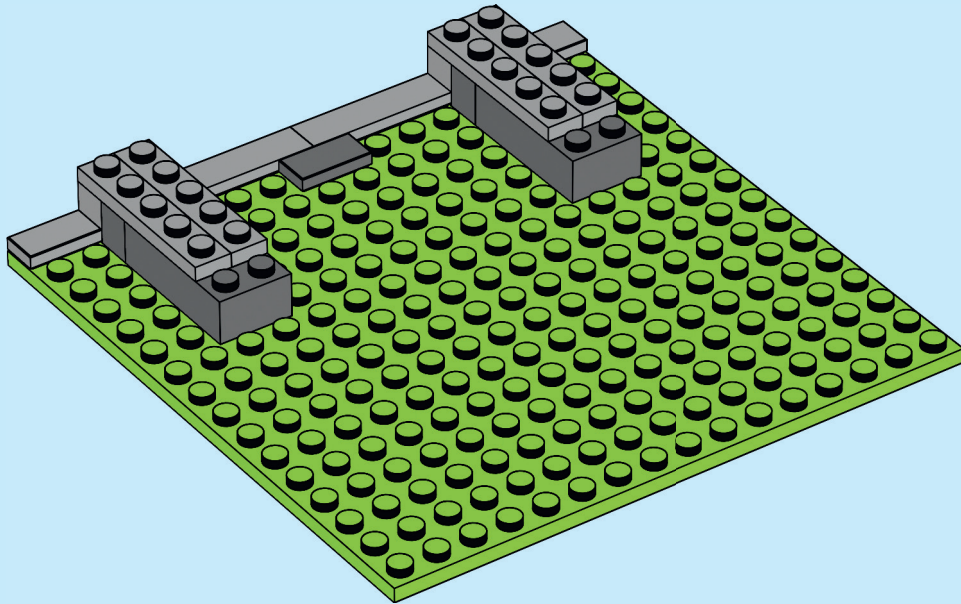

8

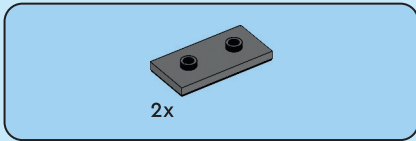

6

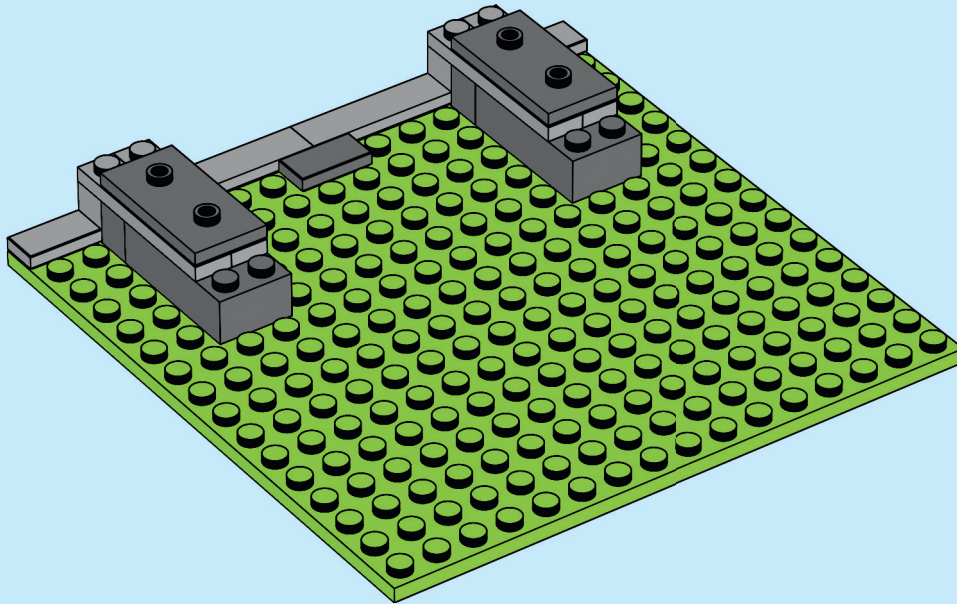

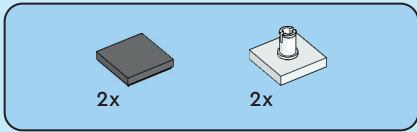

7

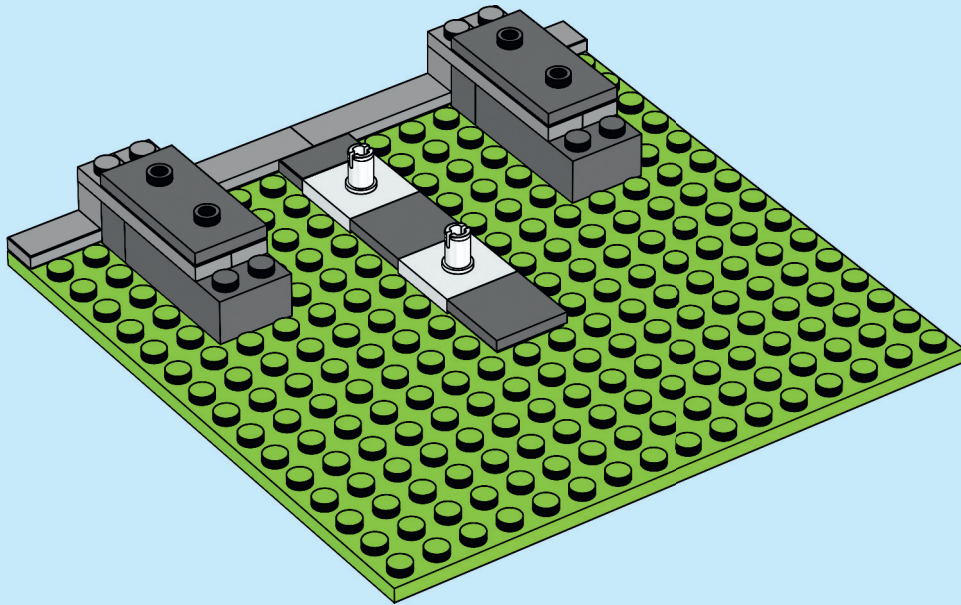

10

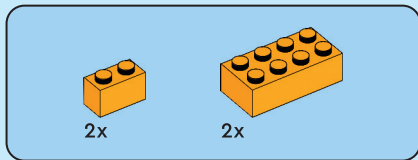

8

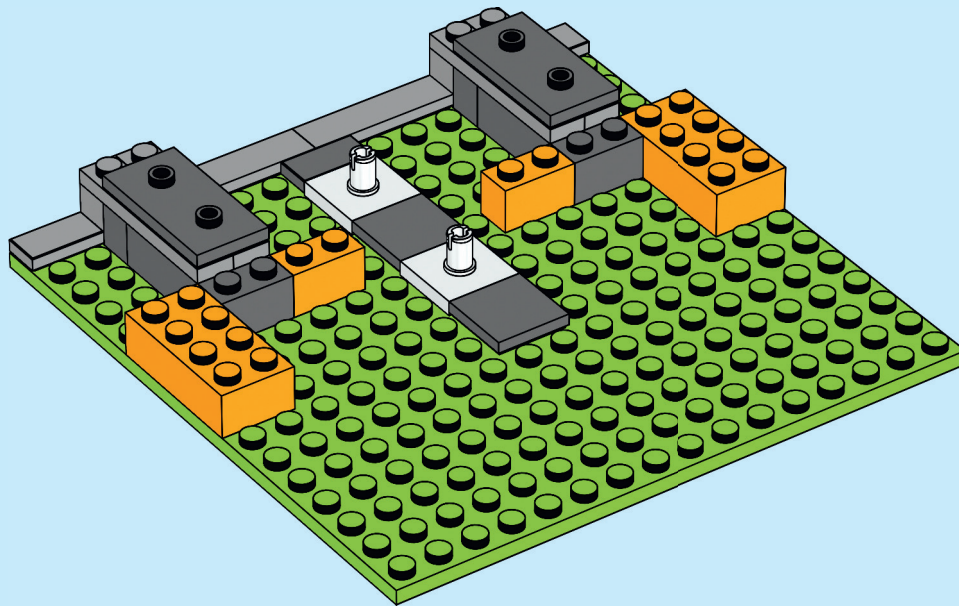

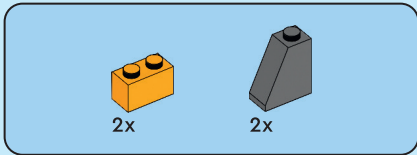

9

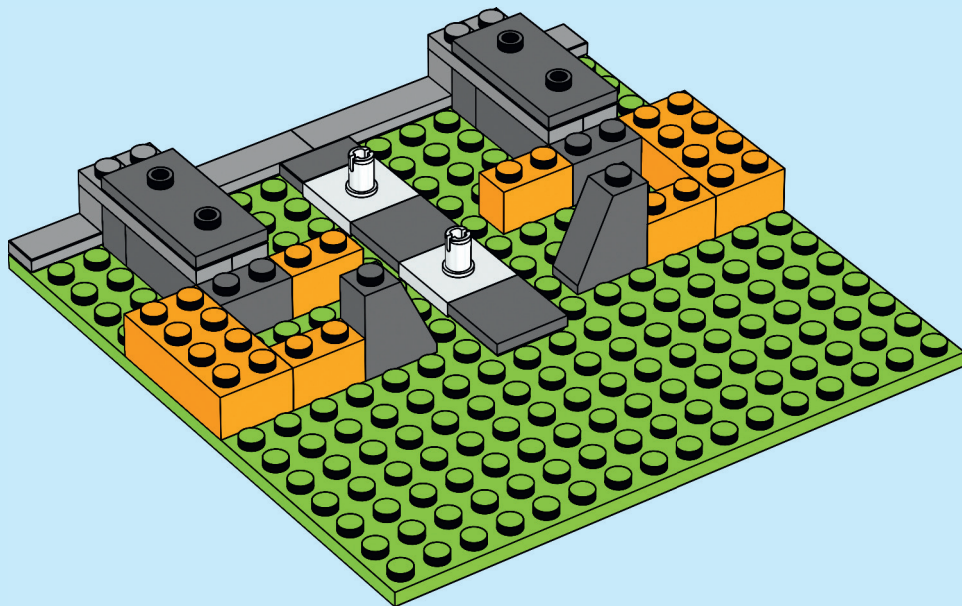

12

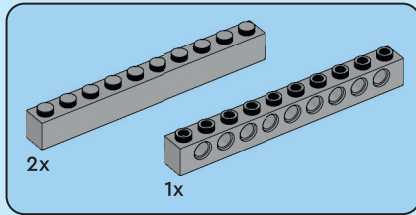

10

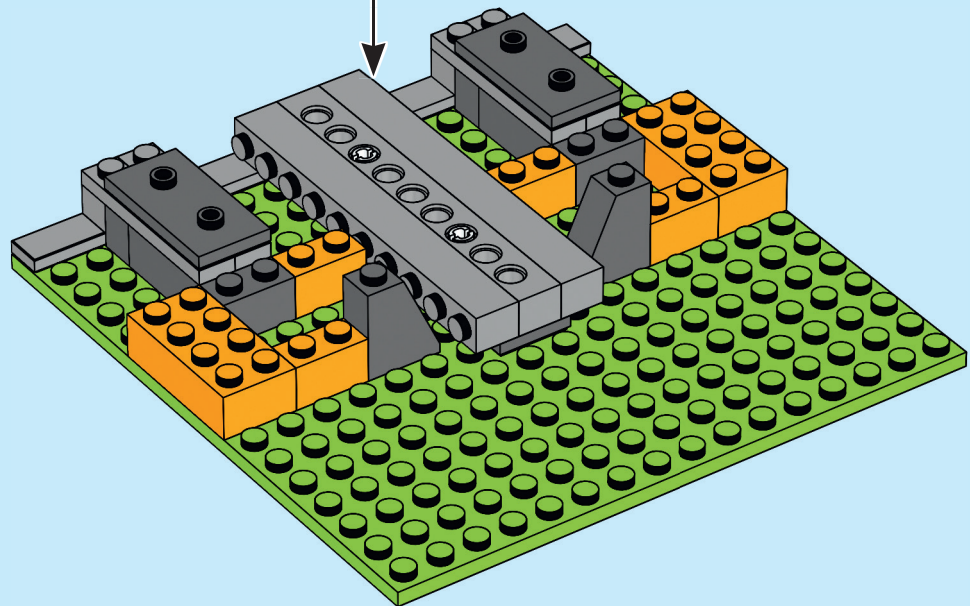
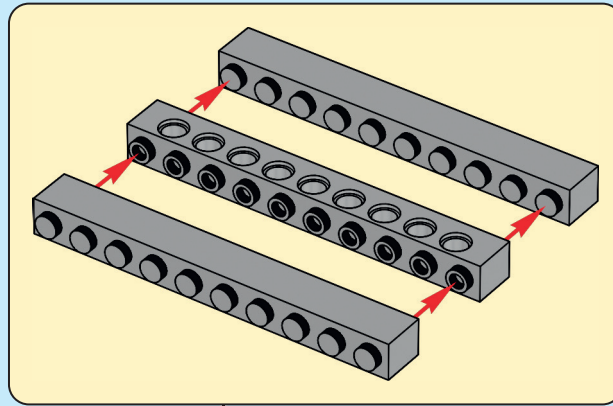

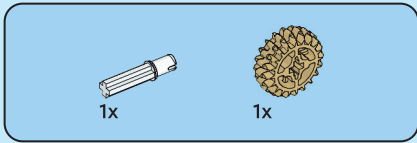

11

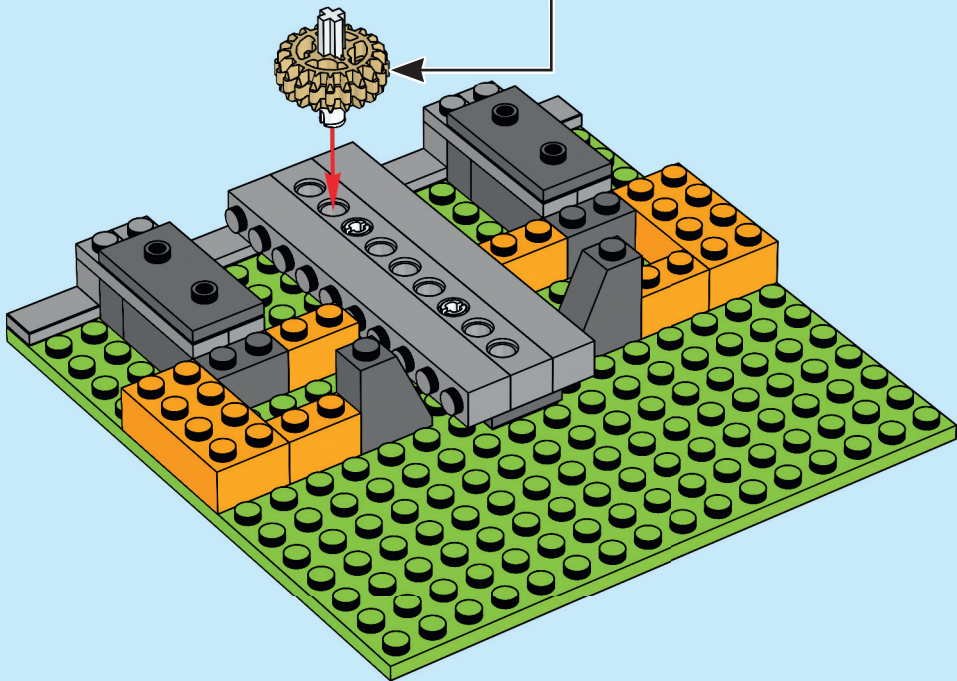
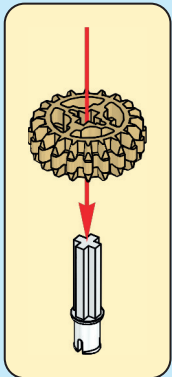

14

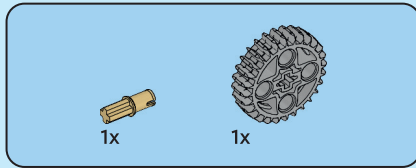

12

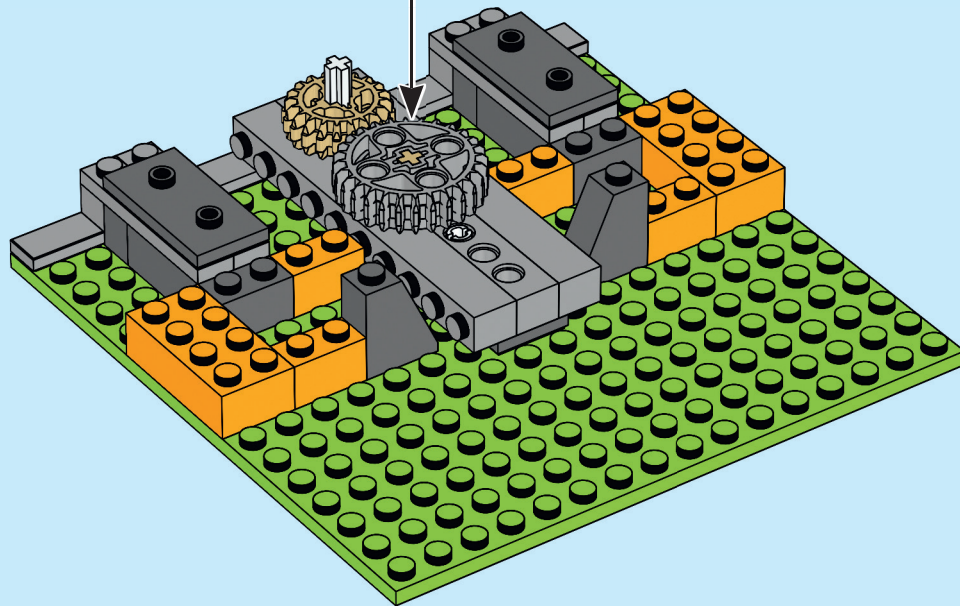
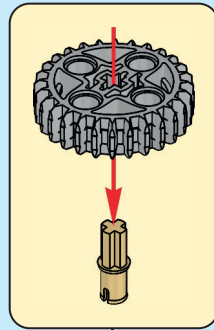

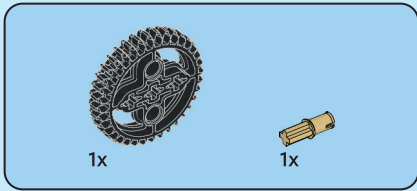

13

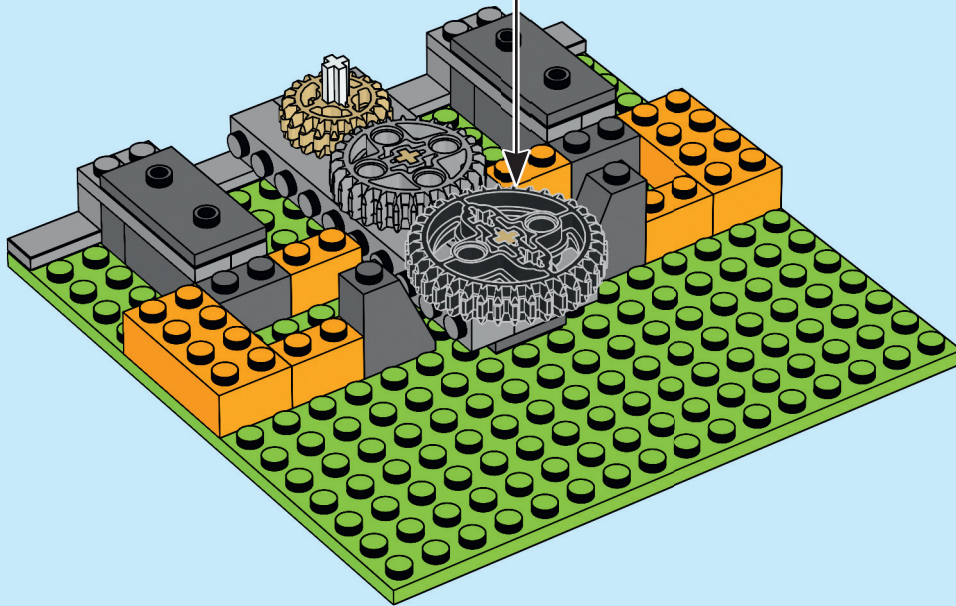
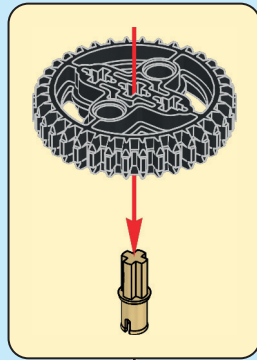

16



2x

14

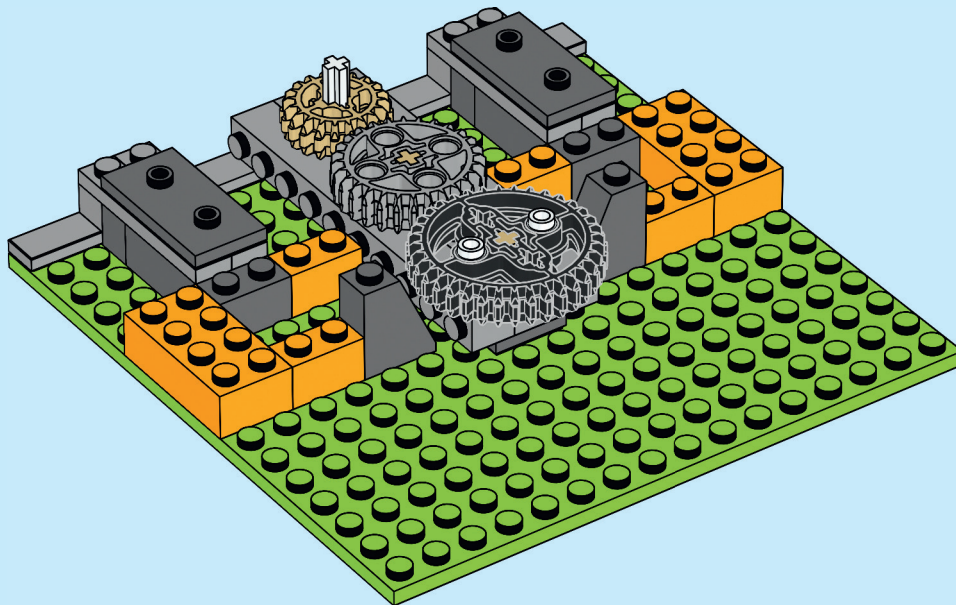

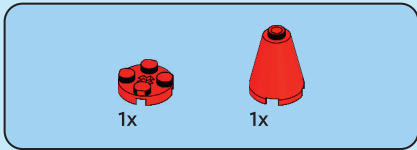

15

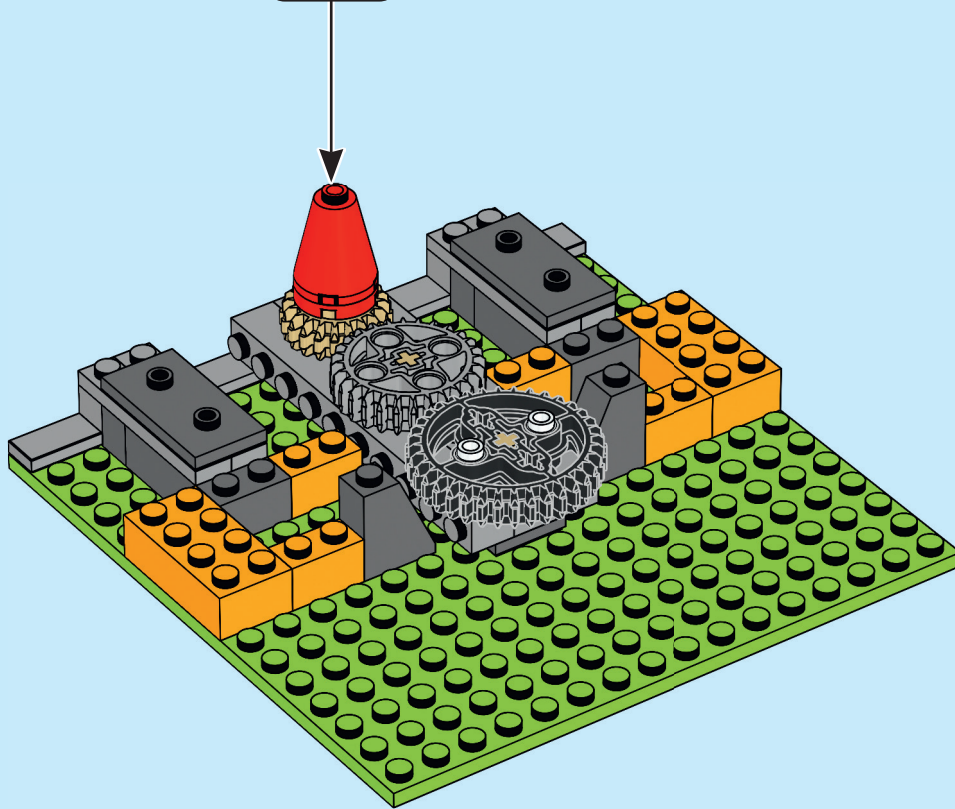
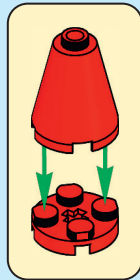

18

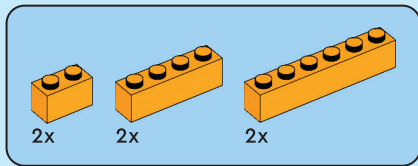

16

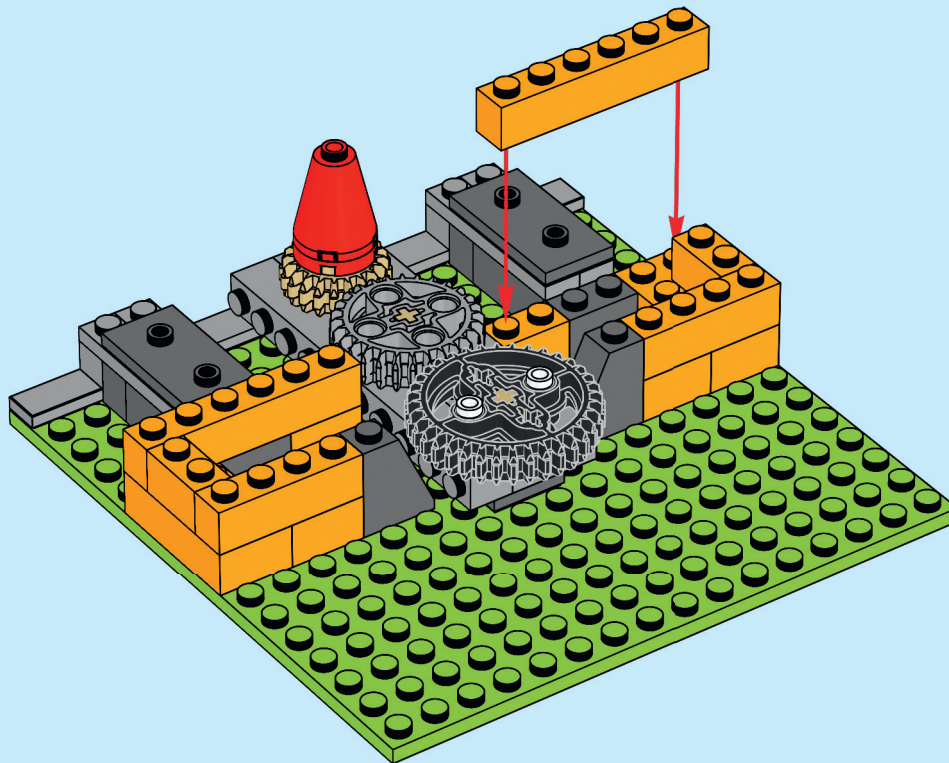

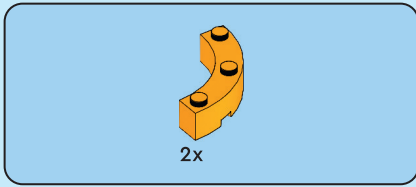

17

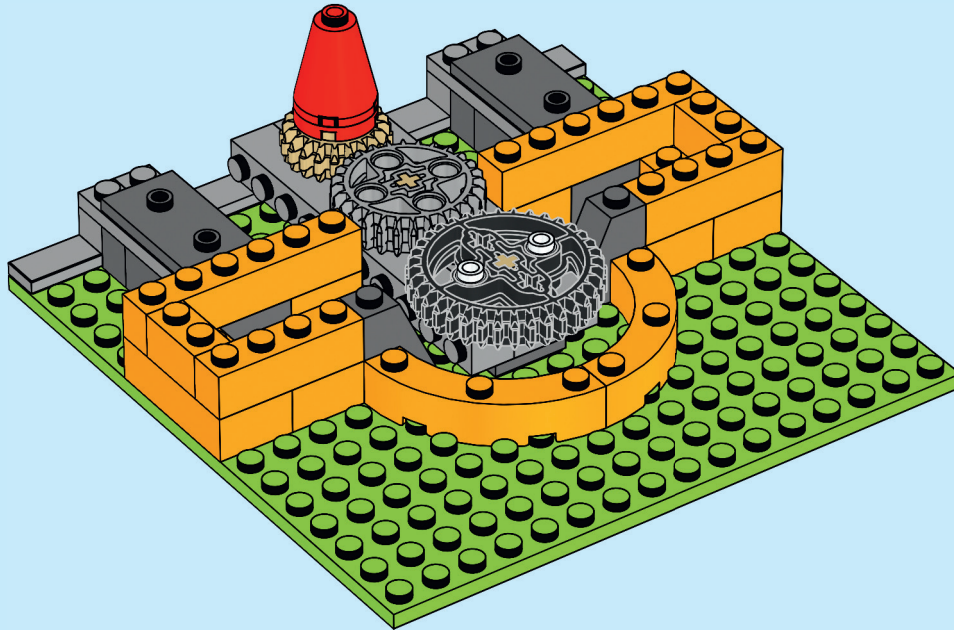

20

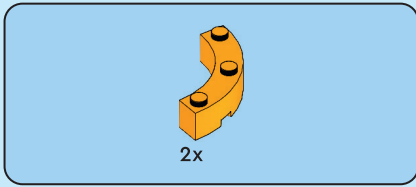

18

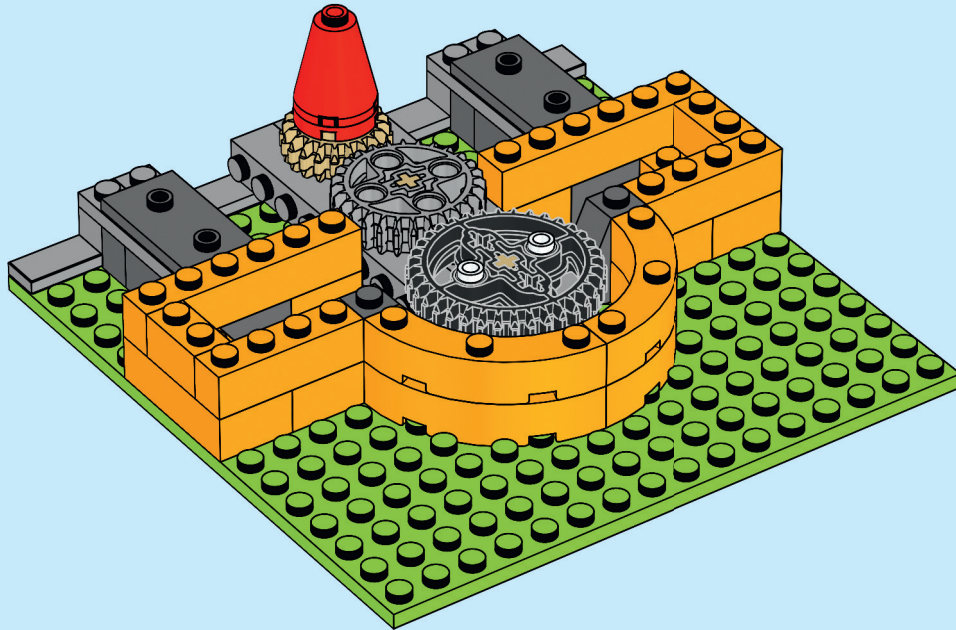



2x

19

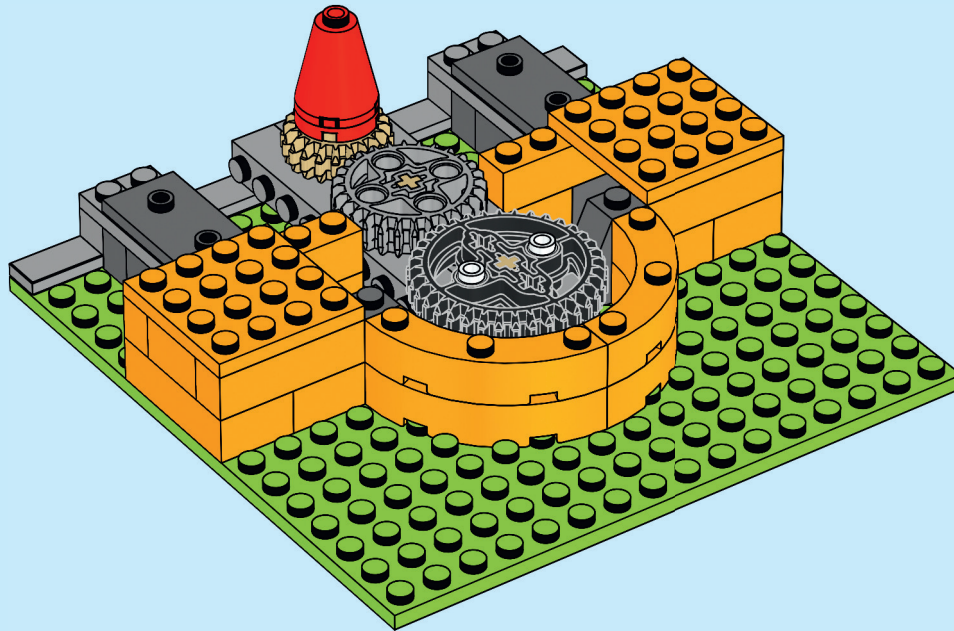

22



2x

20

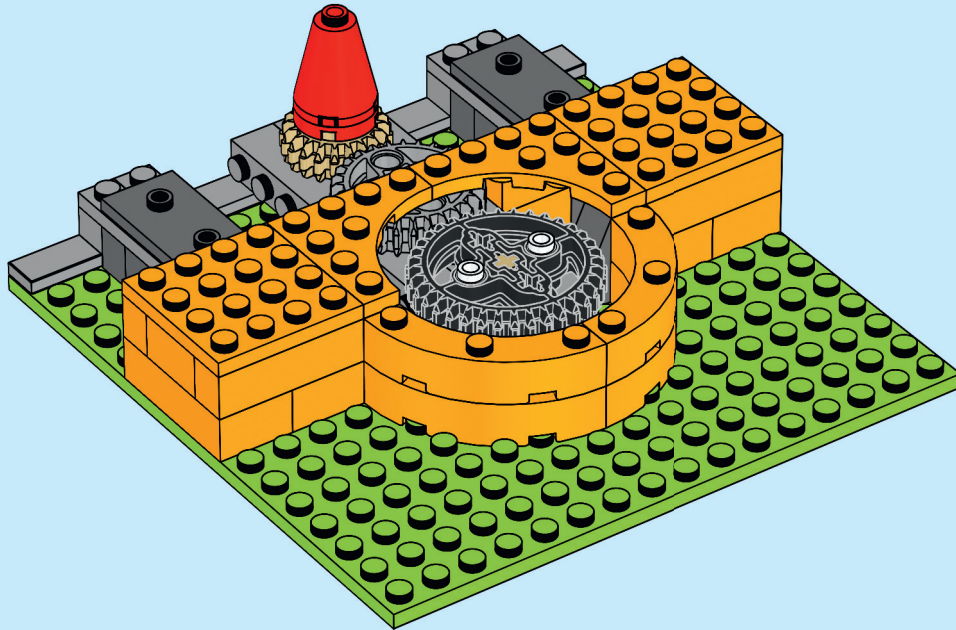



2x

21

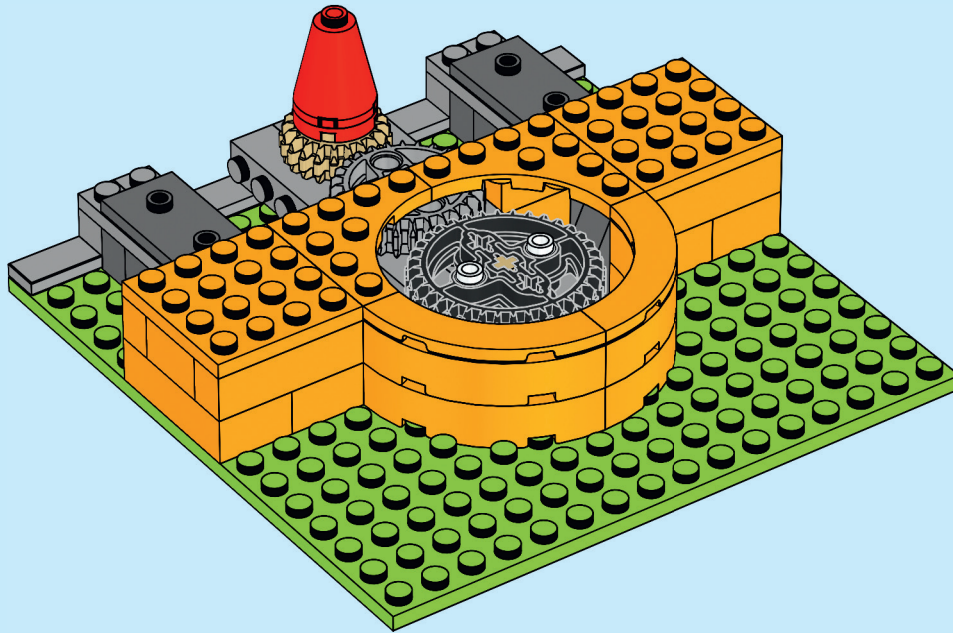

24

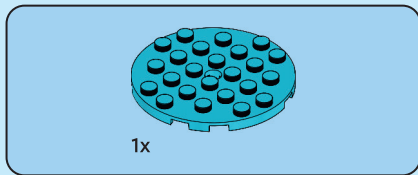

22

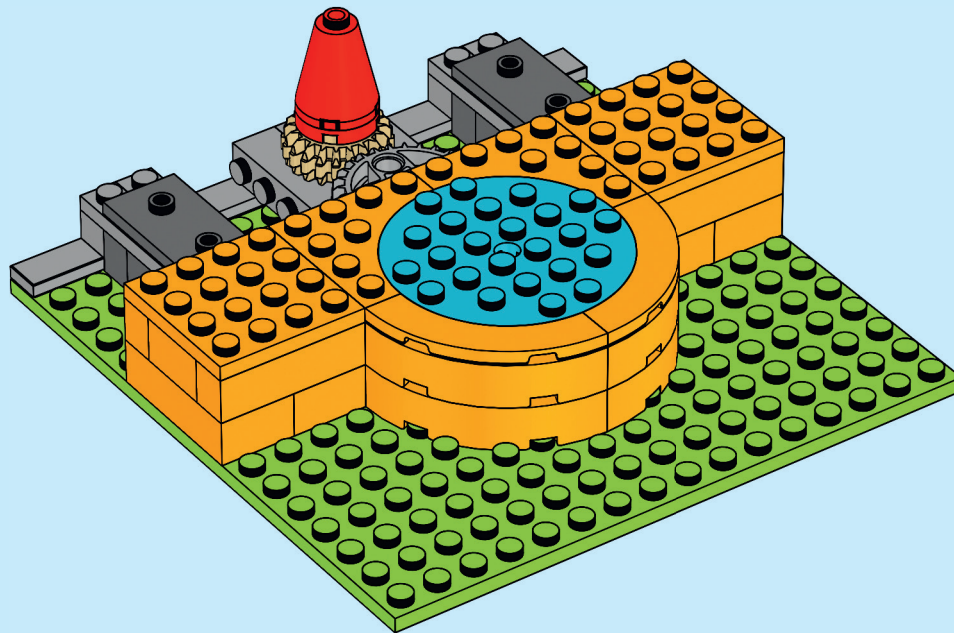

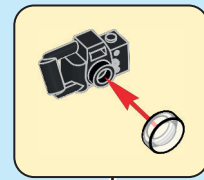
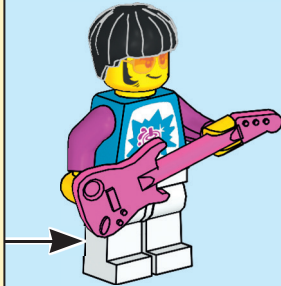
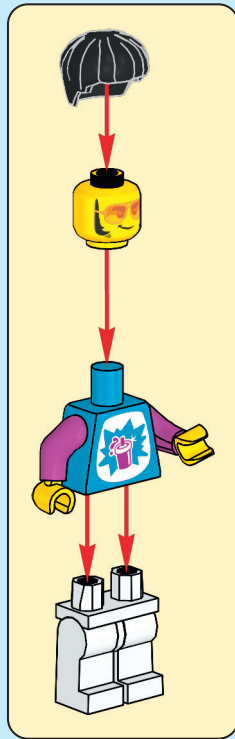

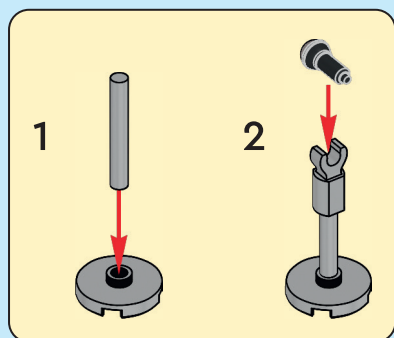

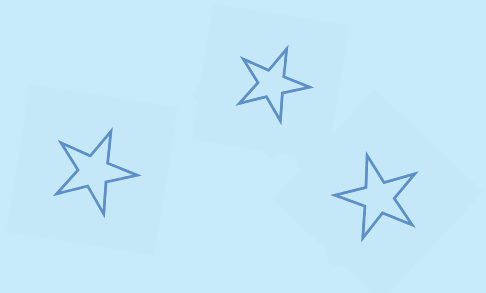

1

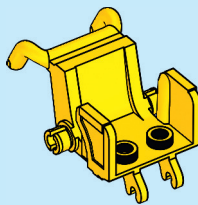

2

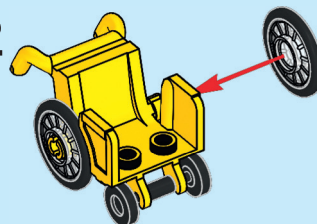



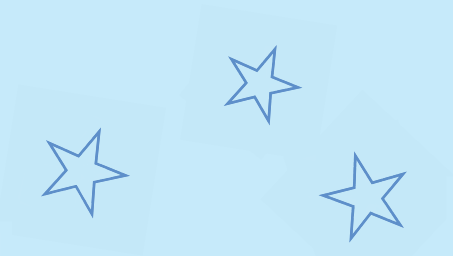

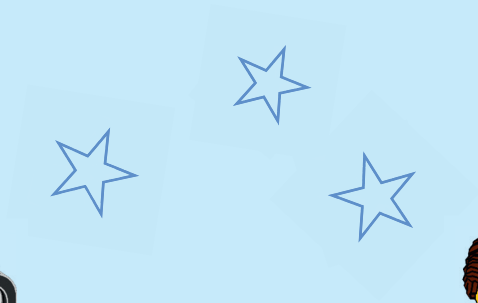

LEGO and the LEGO logo are trademarks of the LEGO Group. ©2023 The LEGO Group. 6469127

FIRST[®] is a registered trademark of For Inspiration and Recognition of Science and Technology (*FIRST*). LEGO[®] is a registered trademark of the LEGO Group. *FIRST*[®] LEGO[®] League and MASTERPIECESM are jointly held trademarks of *FIRST* and the LEGO Group.

©2023 *FIRST* and the LEGO Group. All rights reserved.