

Cinéma 3D

45823

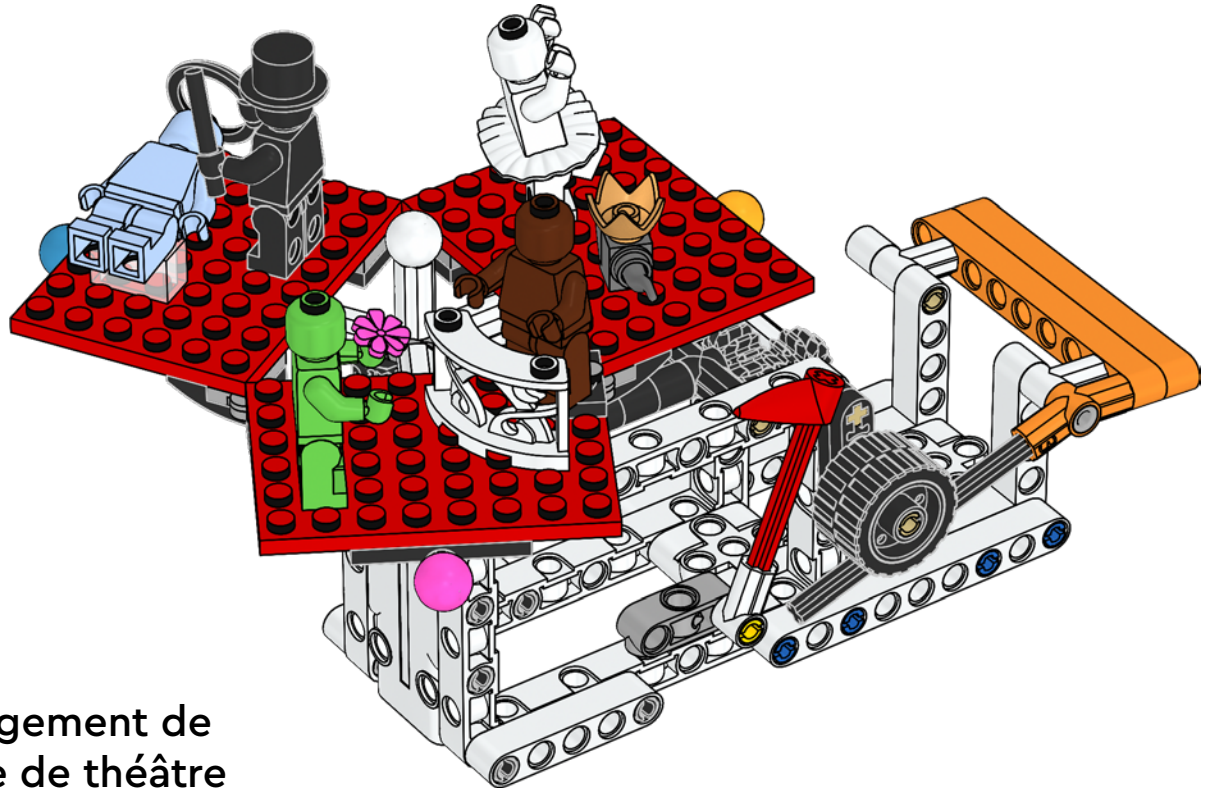

Changement de  
scène de théâtre

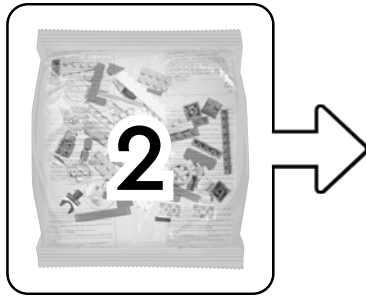
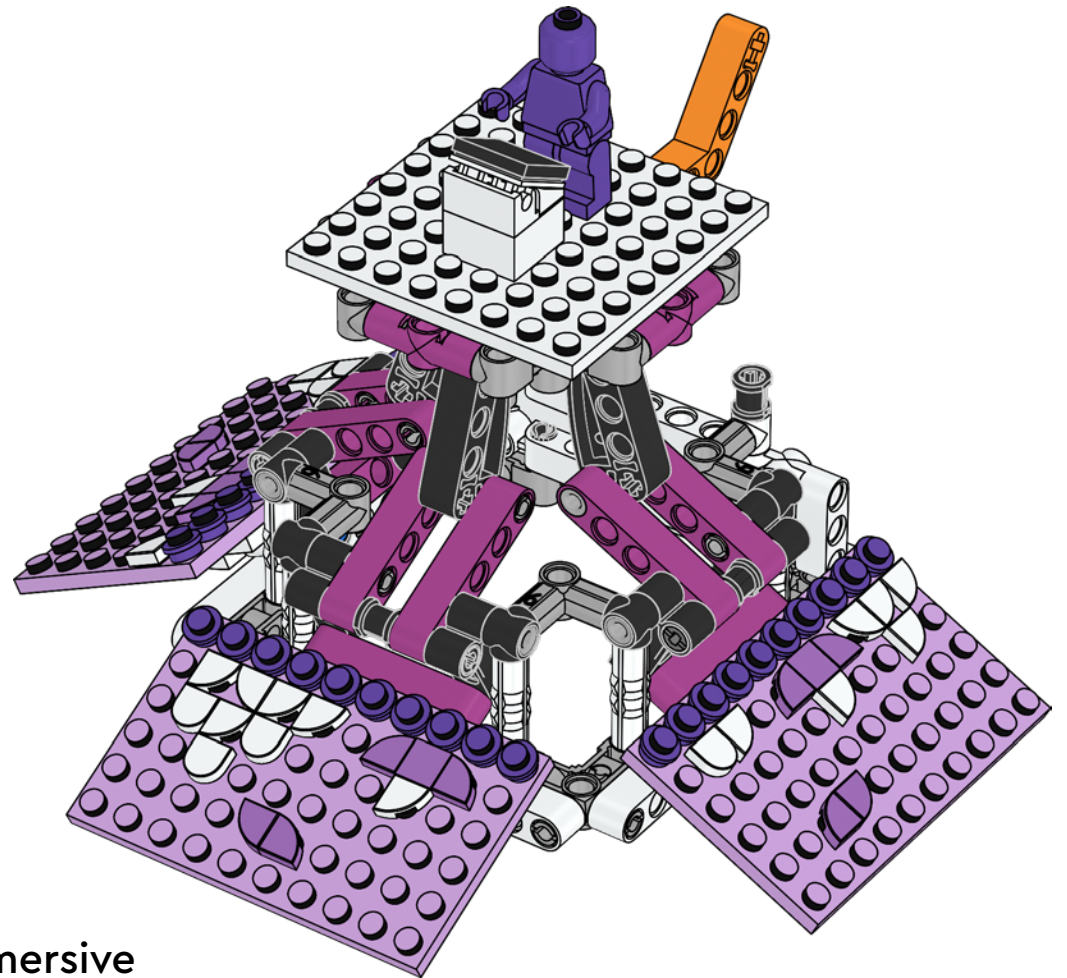
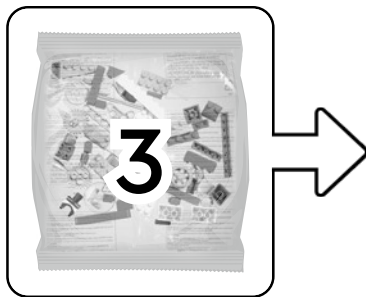

Expérience immersive

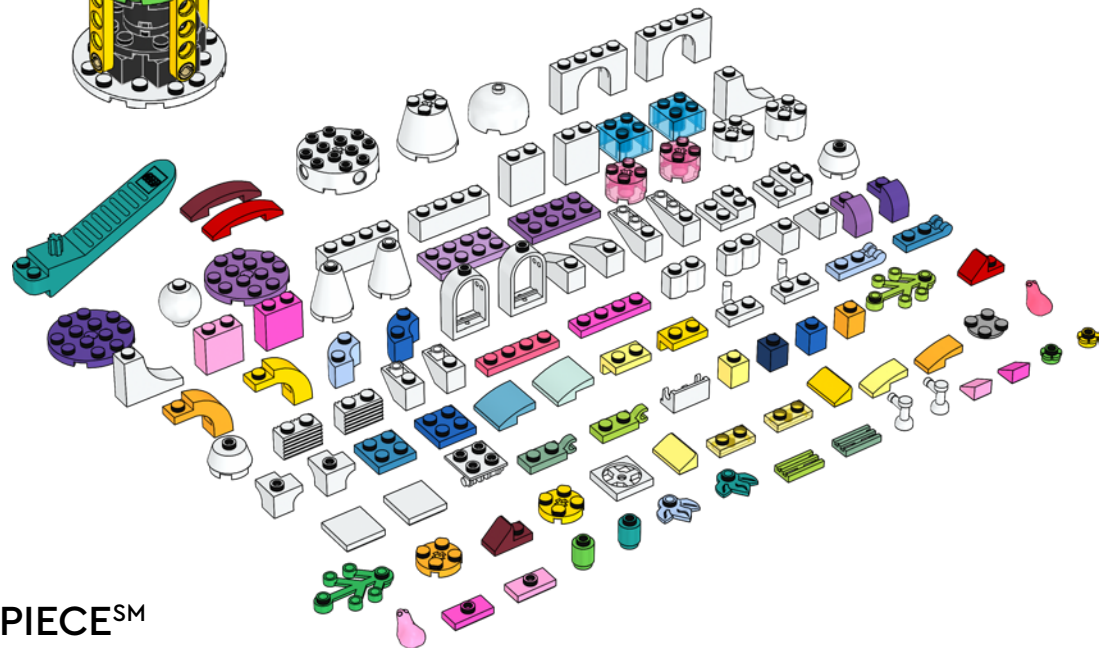
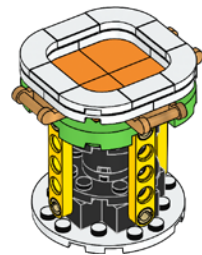
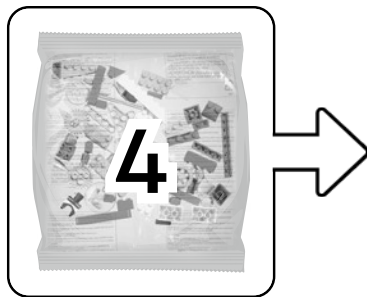

MASTERPIECE<sup>SM</sup>

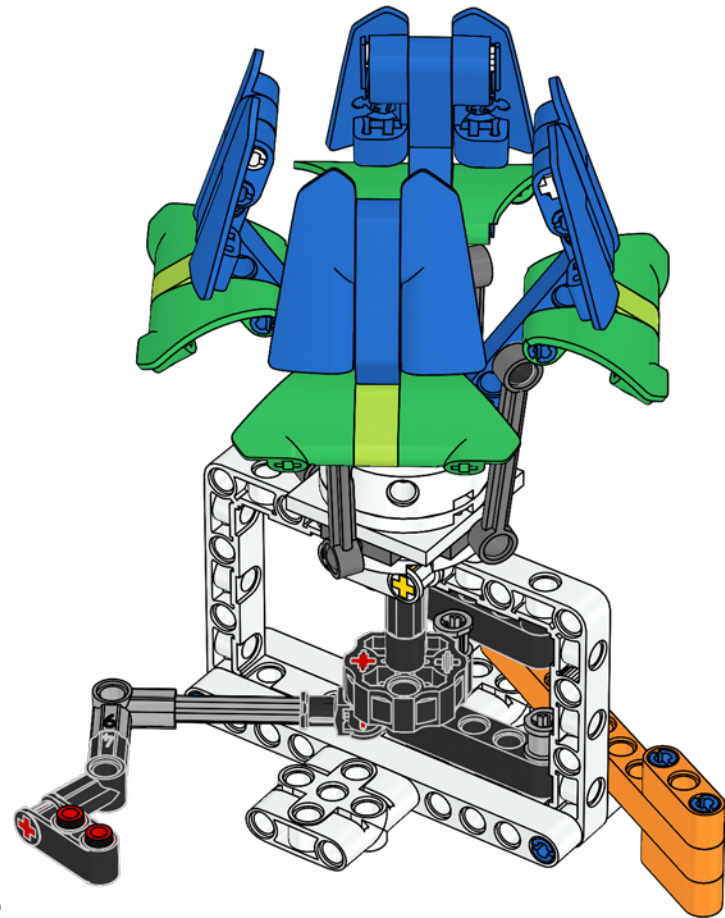
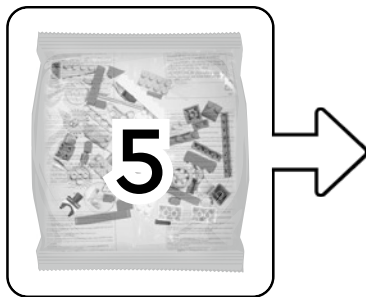

Statue en réalité  
augmentée



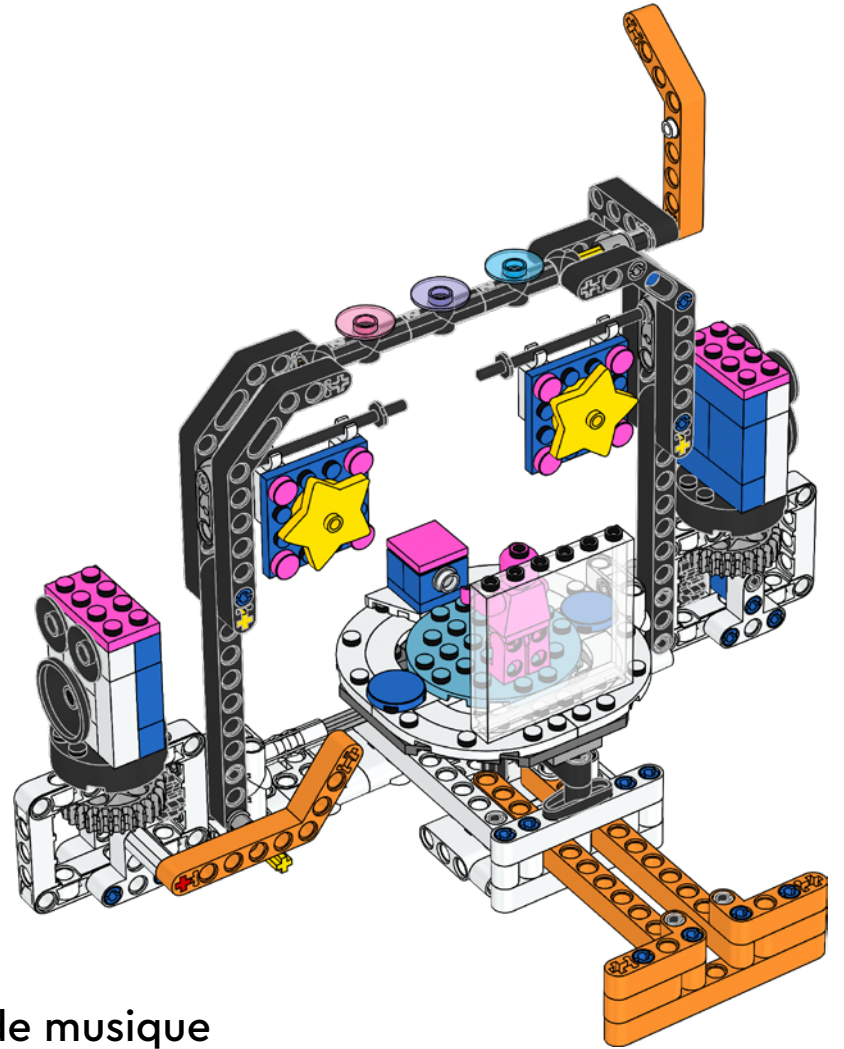
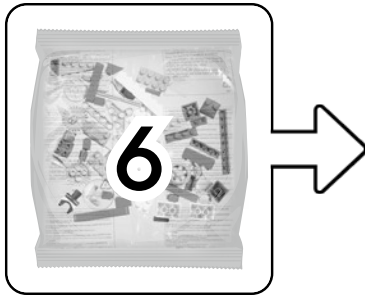

Concert de musique

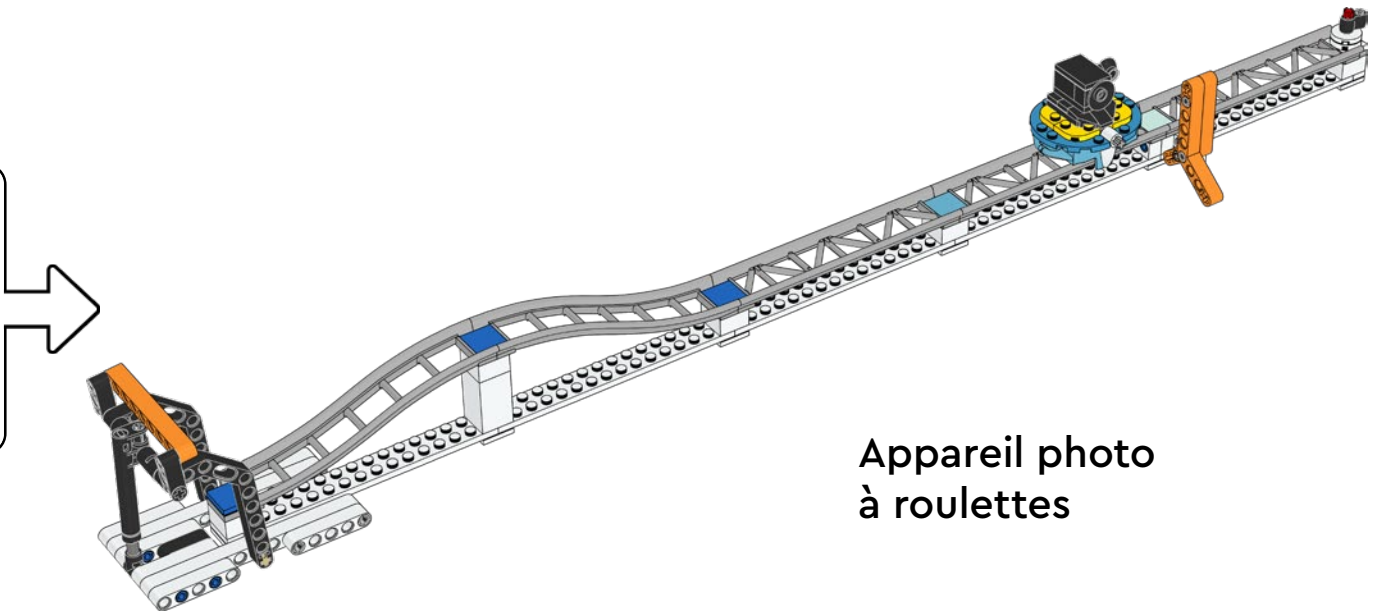

Appareil photo  
à roulettes

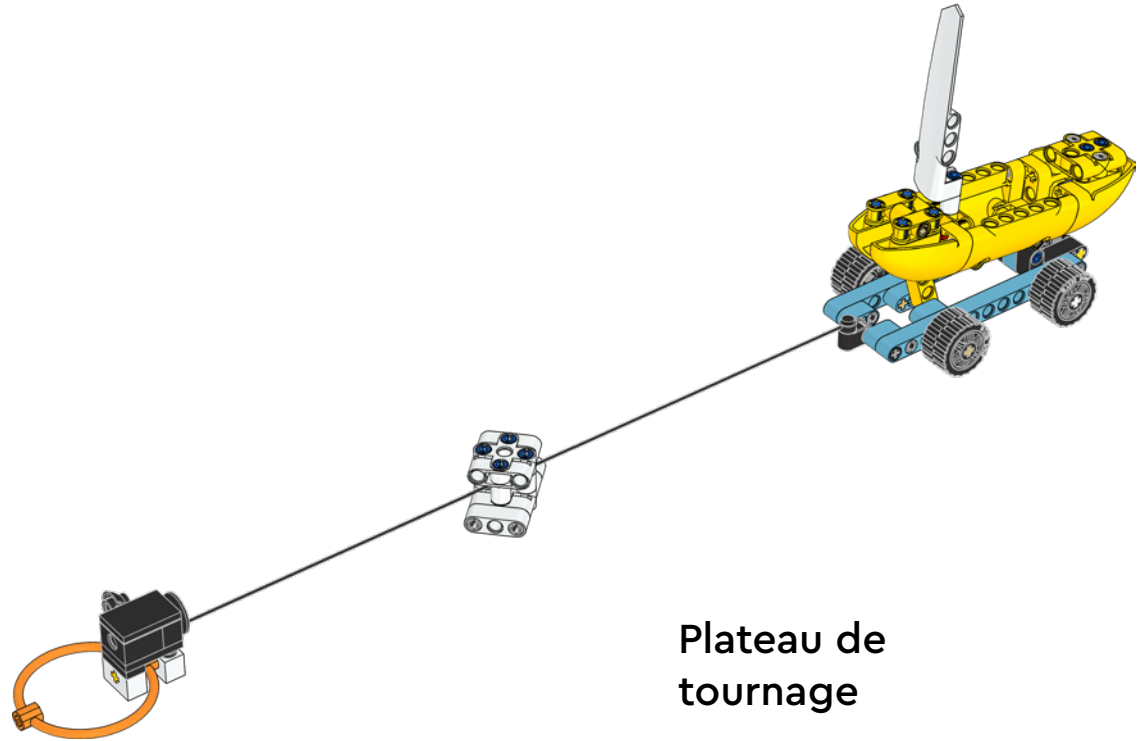
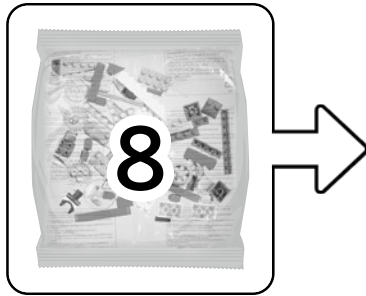

Plateau de  
tournage



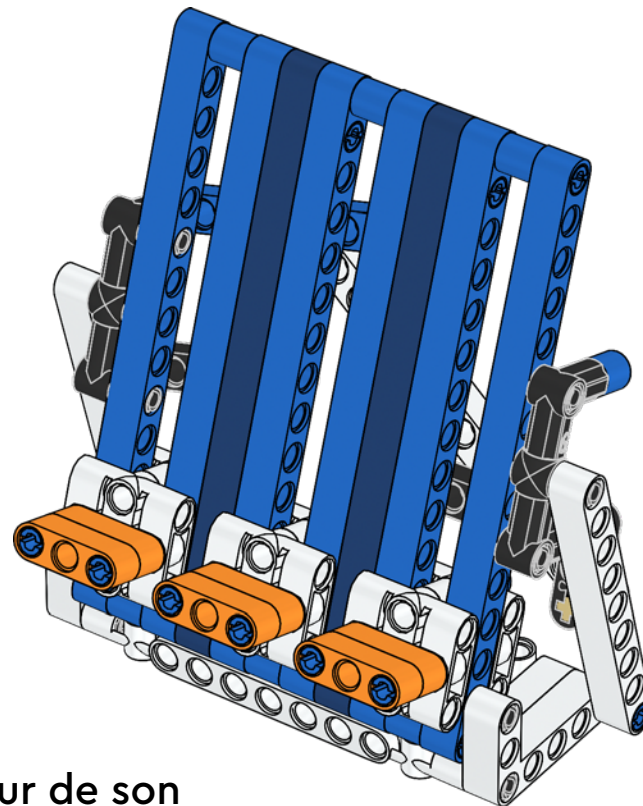
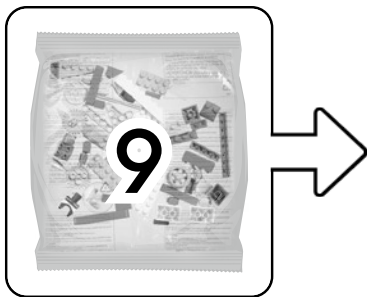

Mélangeur de son

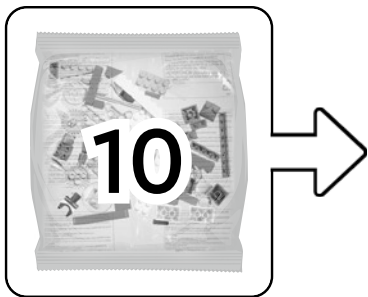

Spectacle  
de lumière

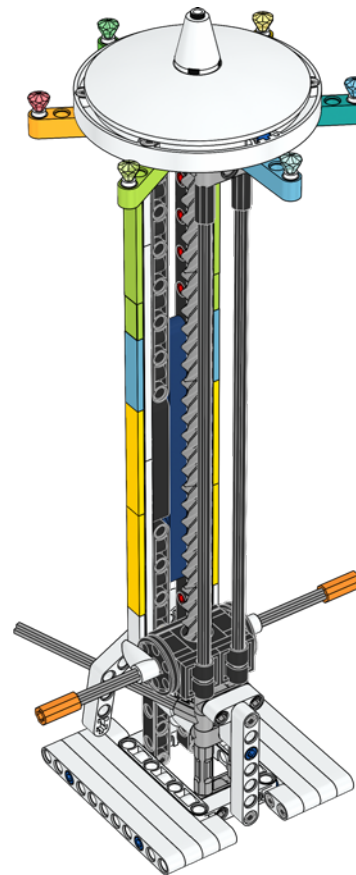

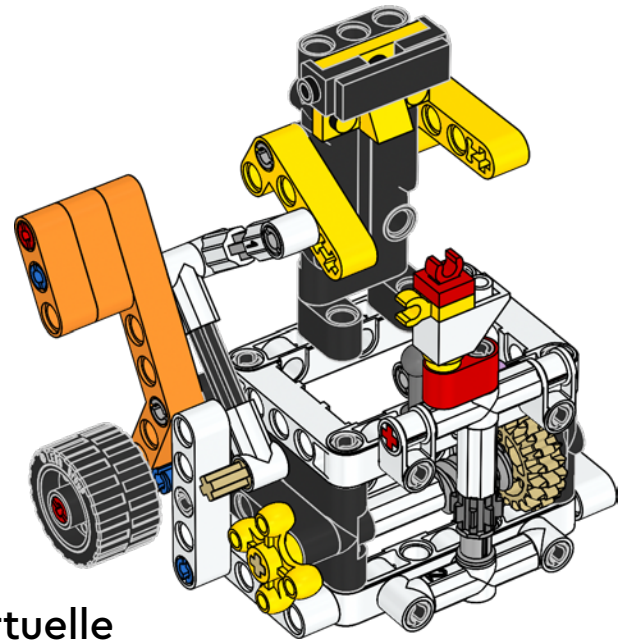
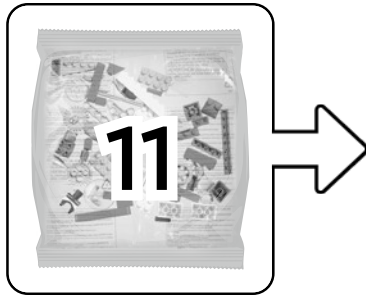

Artiste en réalité virtuelle

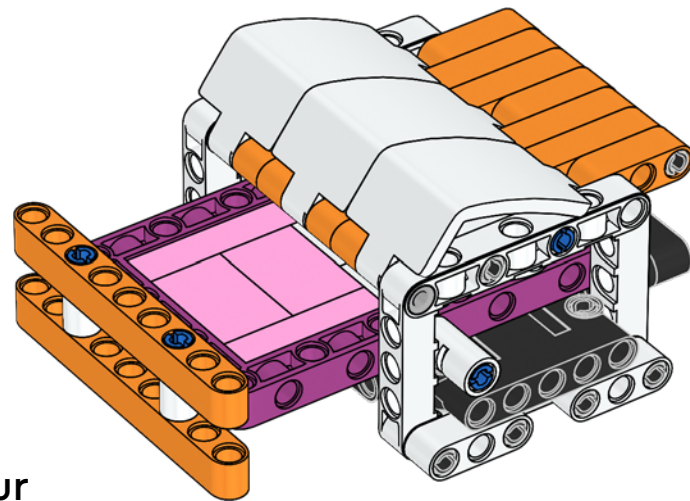
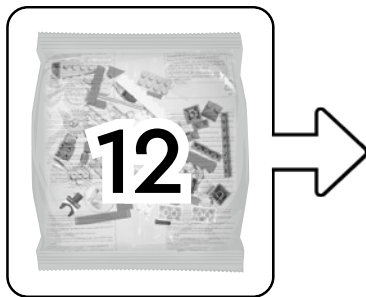

Créateur  
d'artisanat

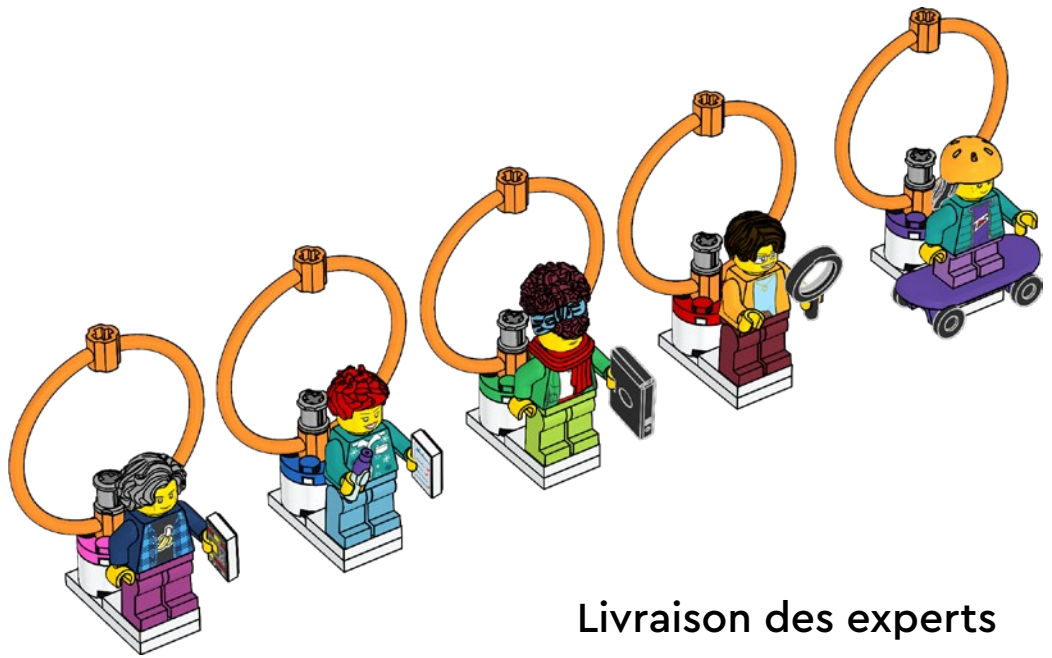
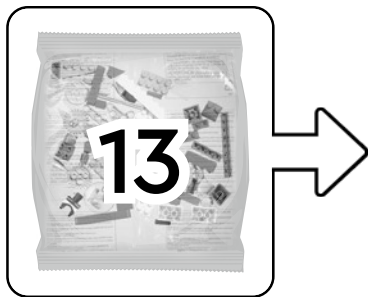

Livraison des experts

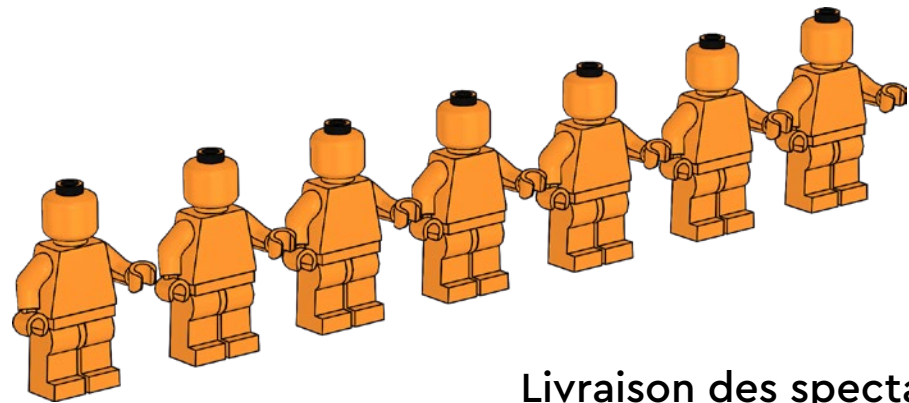
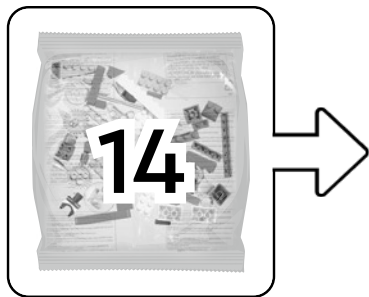

Livraison des spectateurs



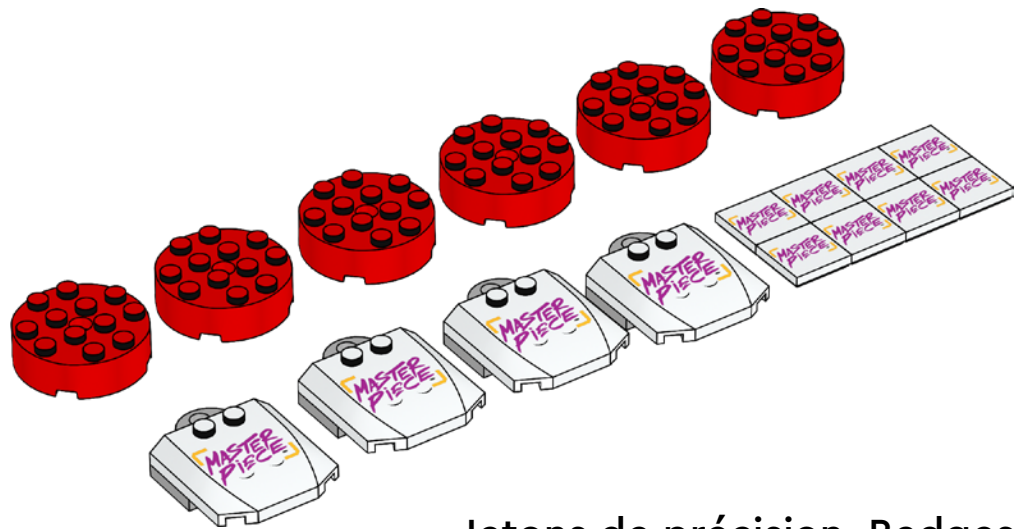
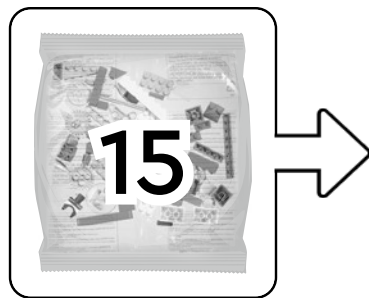

Jetons de précision, Badges  
d'entraîneur, Tuiles de saison

LEGO and the LEGO logo are trademarks of the/sont des marques de commerce du/son marcas registradas de LEGO Group.  
©2023 The LEGO Group.

FIRST™ is a registered trademark of For Inspiration and Recognition of Science and Technology (FIRST). LEGO® is a registered  
trademark of the LEGO Group. FIRST™ LEGO® League and MASTERPIECE™ are jointly held trademarks of FIRST and the LEGO Group.  
©2023 FIRST and the LEGO Group. All rights reserved.