

45823

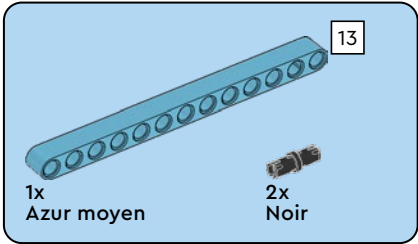

1

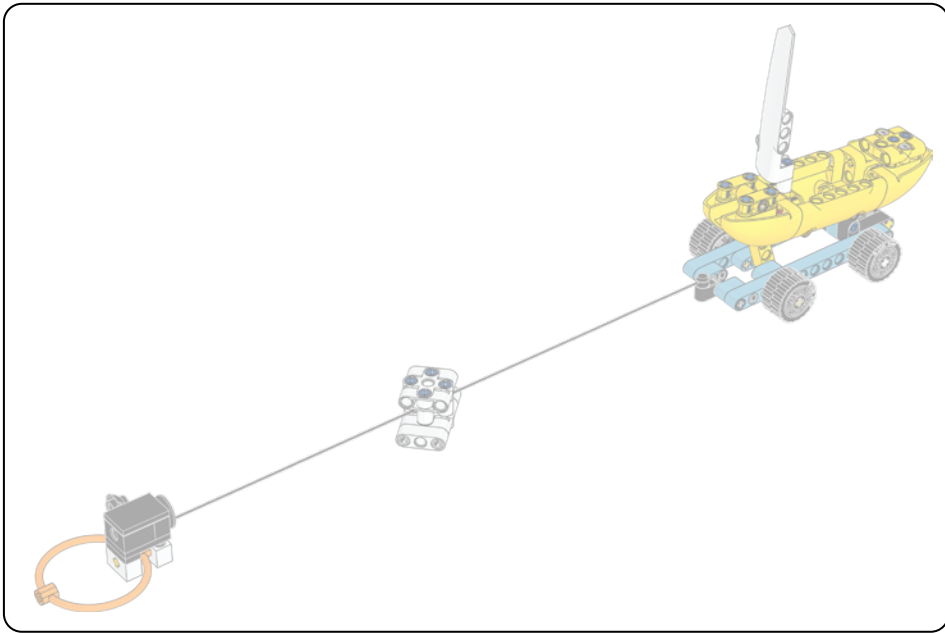
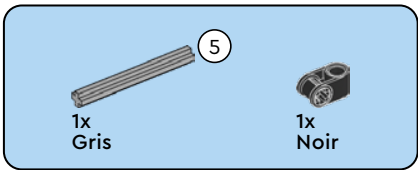
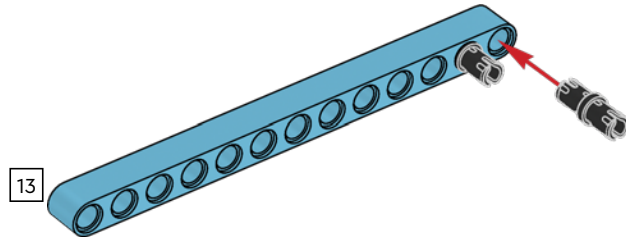

2

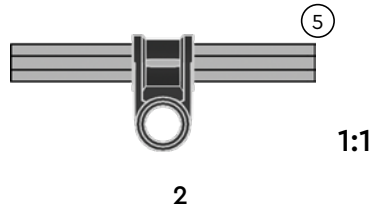

1x
Rouge

3

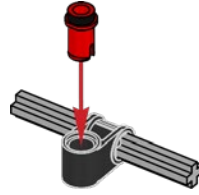

2x
Noir

2x
Azur moyen

4

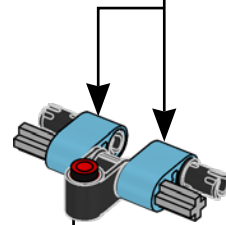
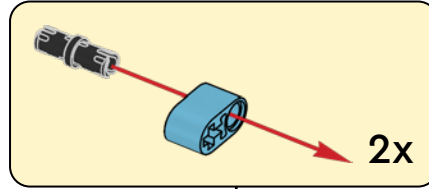

5

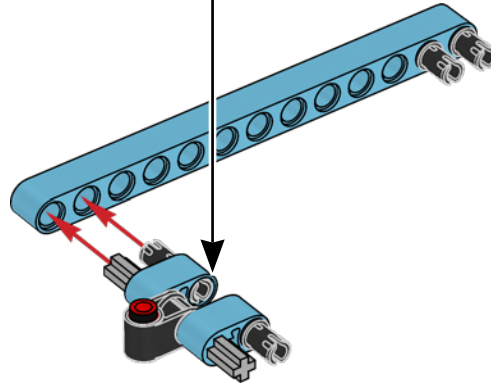

3

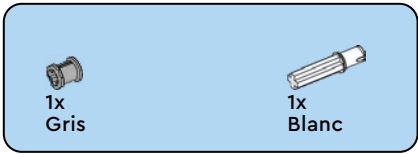

6

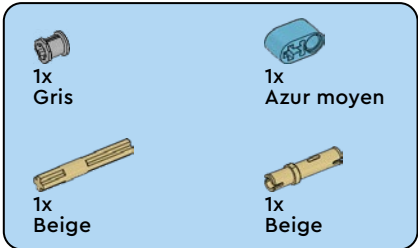
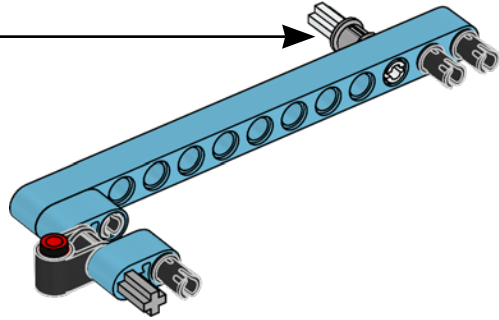
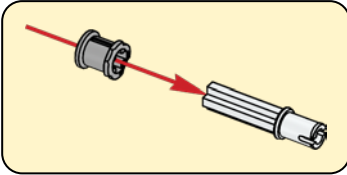

7

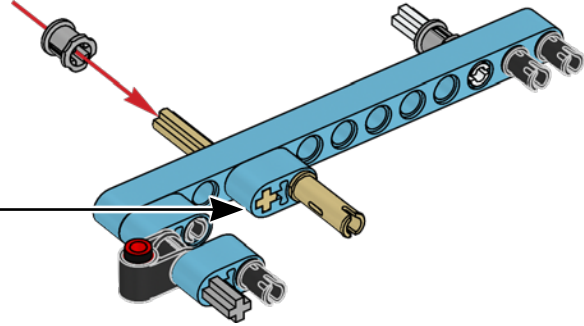
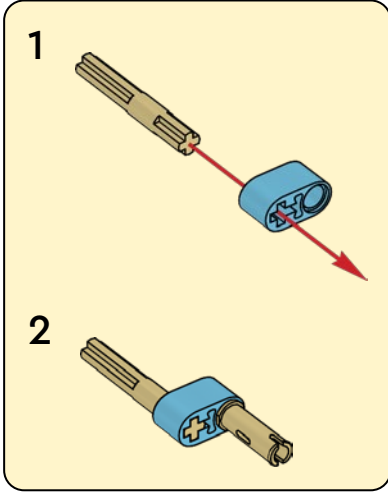

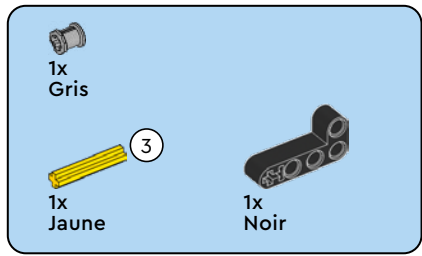

8

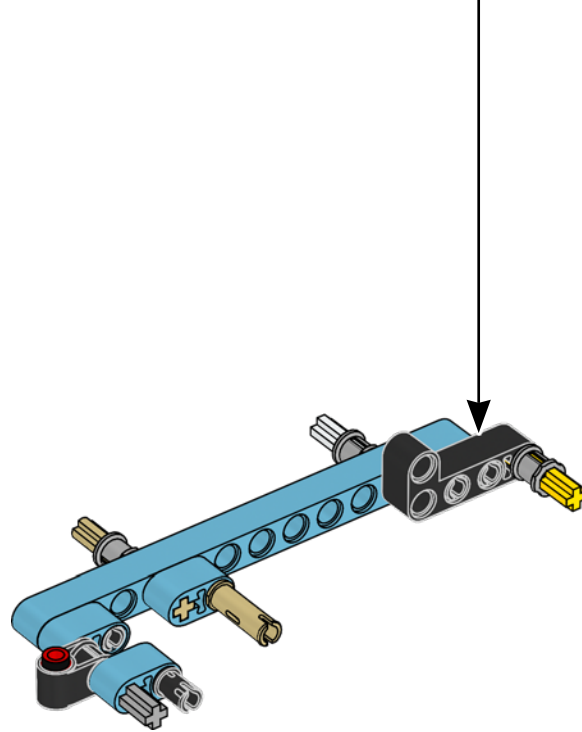
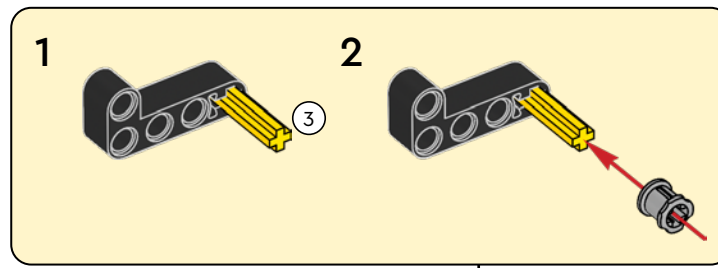

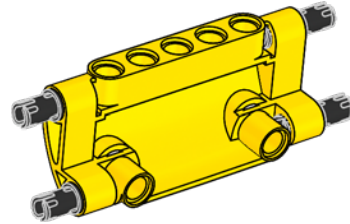
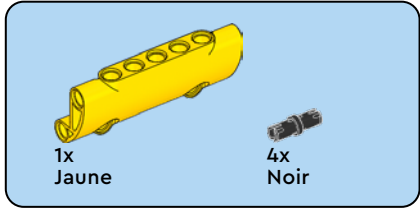
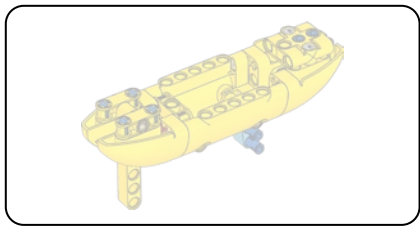

9

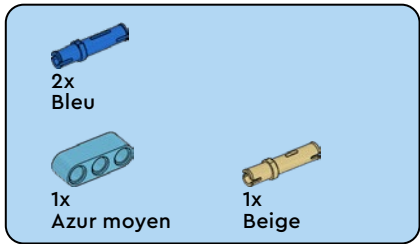

10

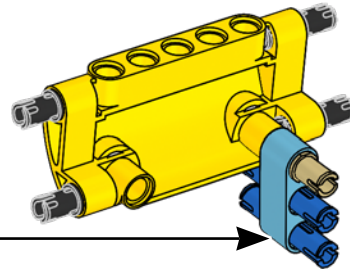
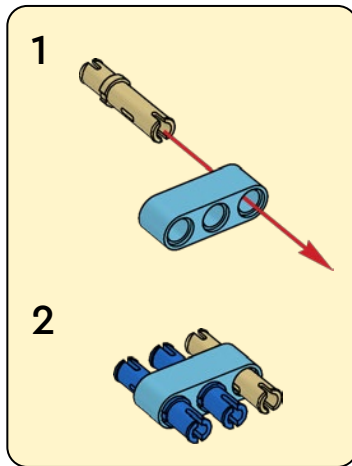

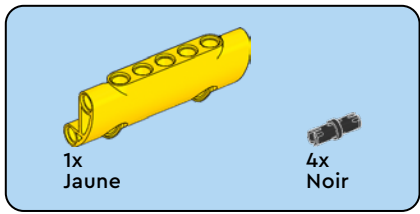

11

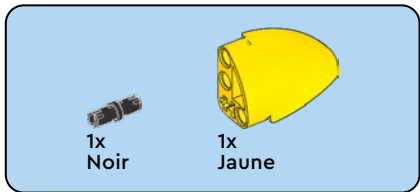
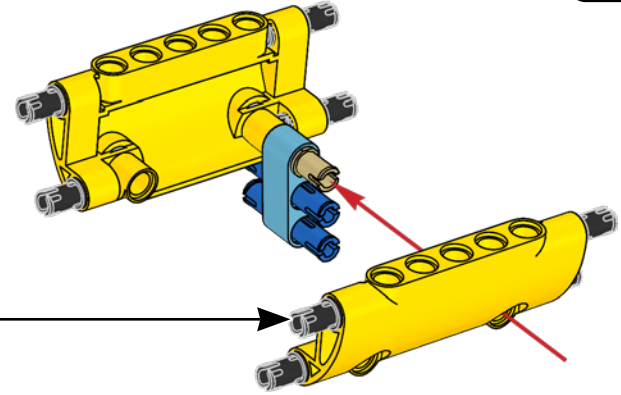
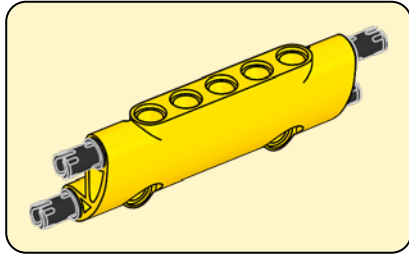

12

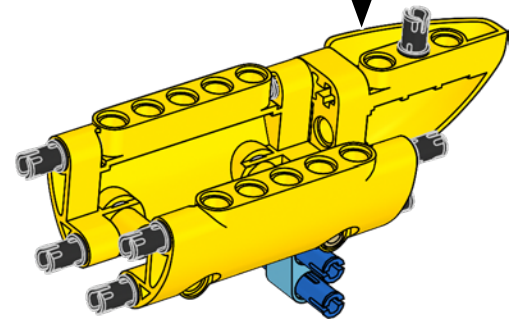
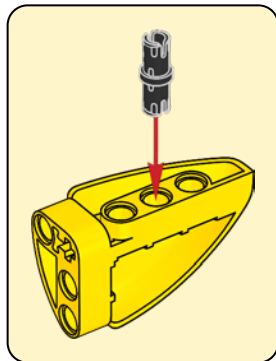

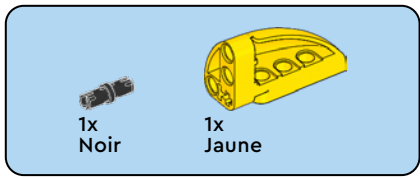

13

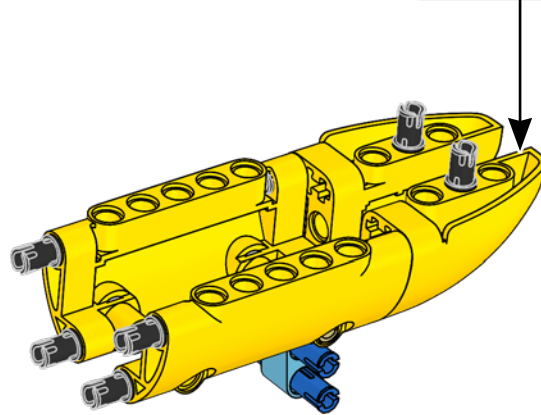
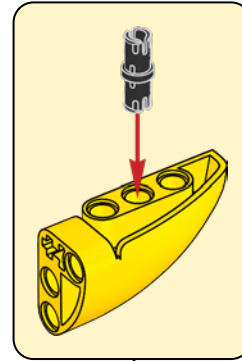

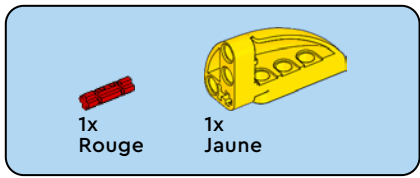

14

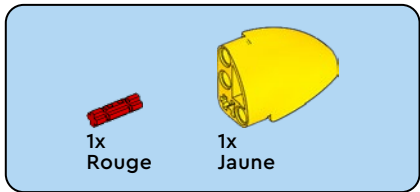
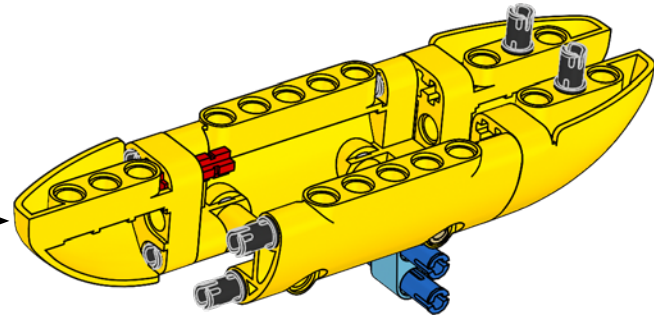
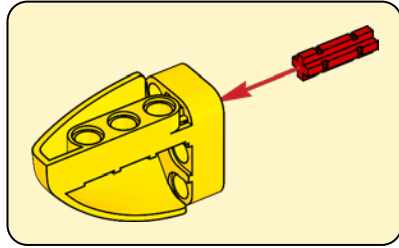

15

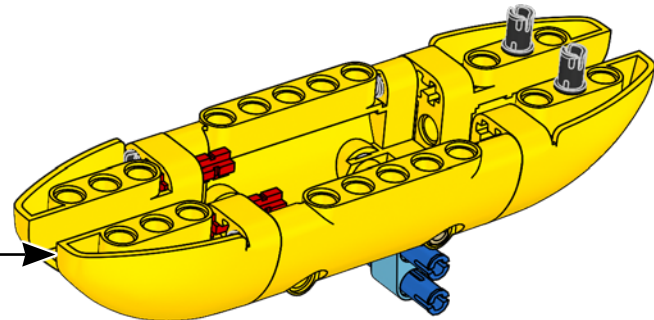
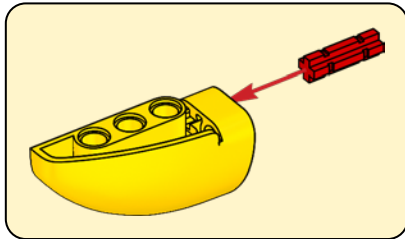

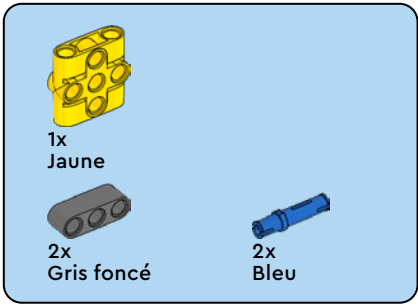

16

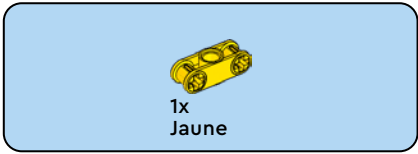
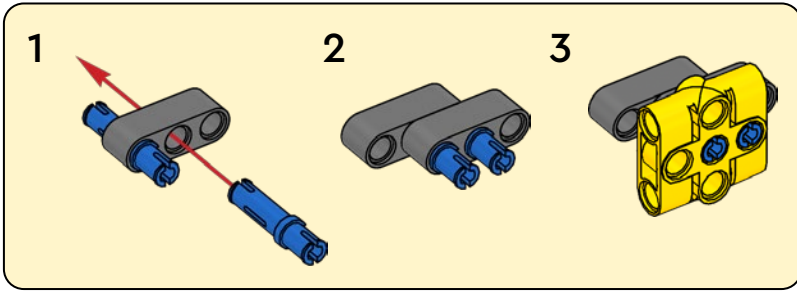

17

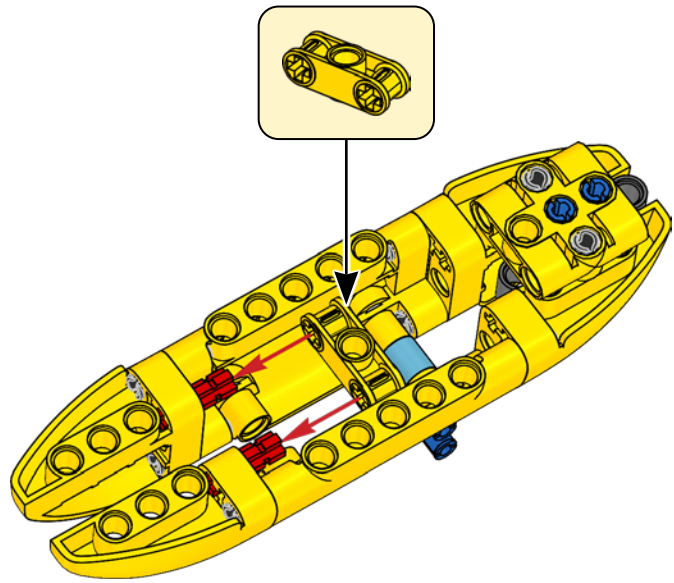
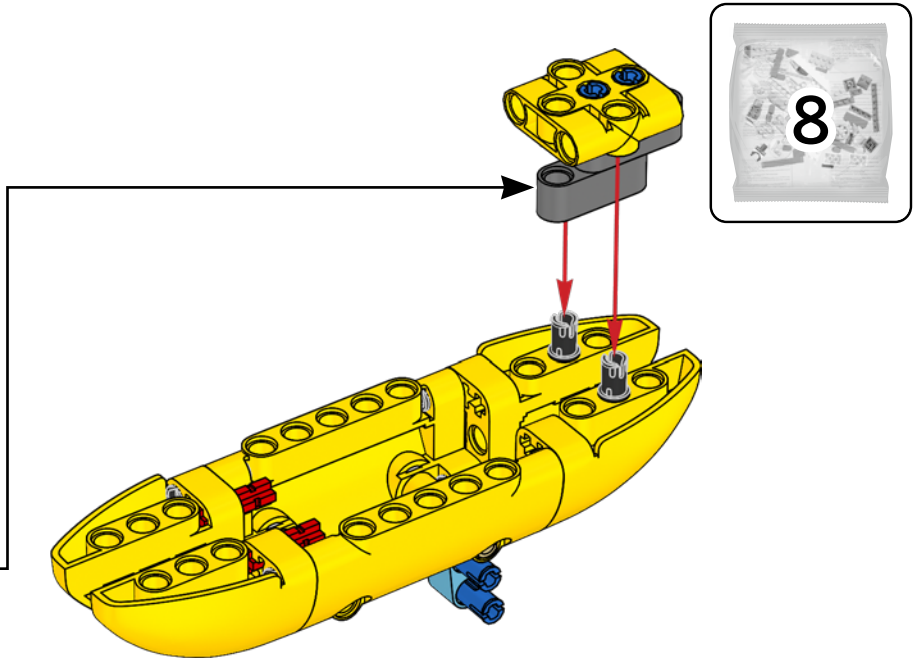

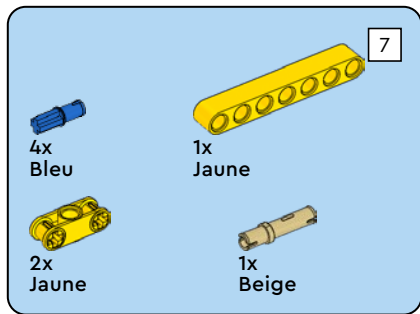

18

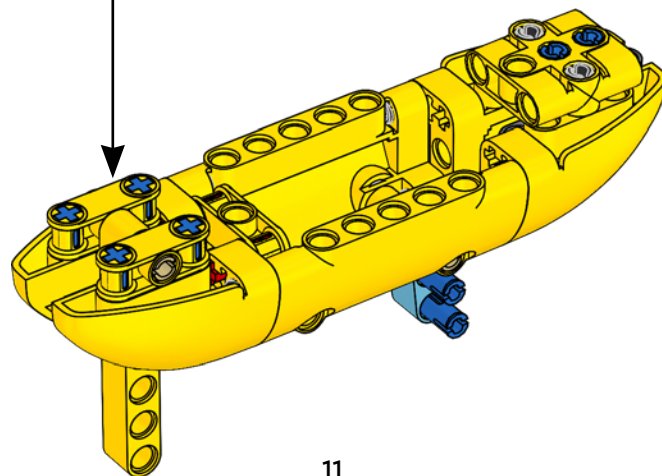
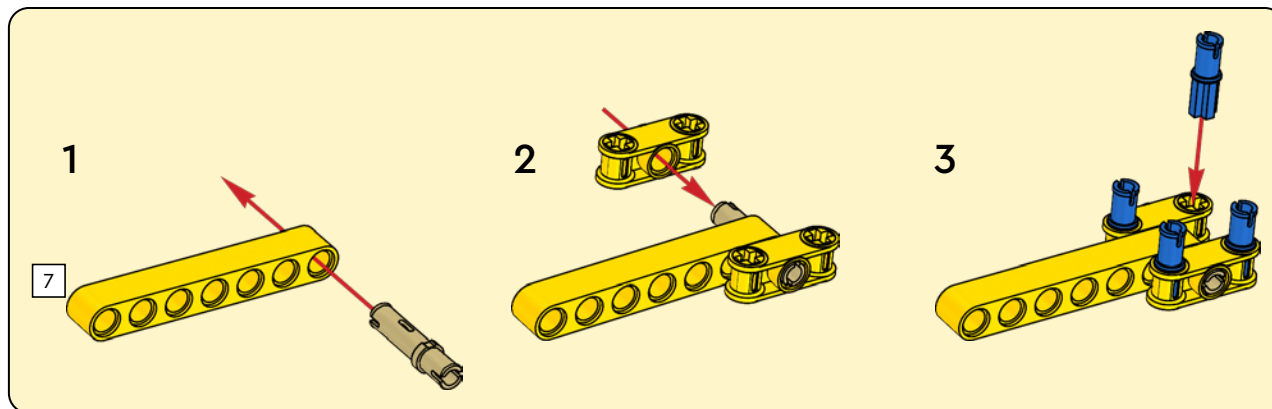

19

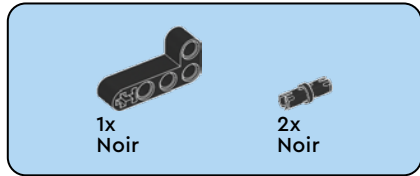
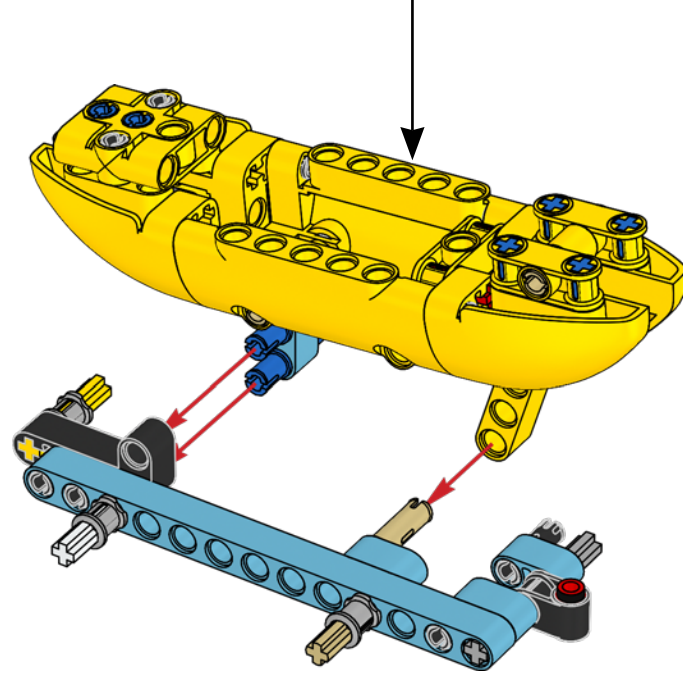

20

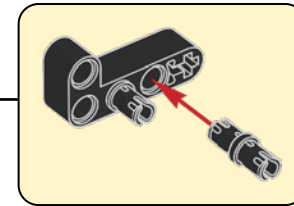
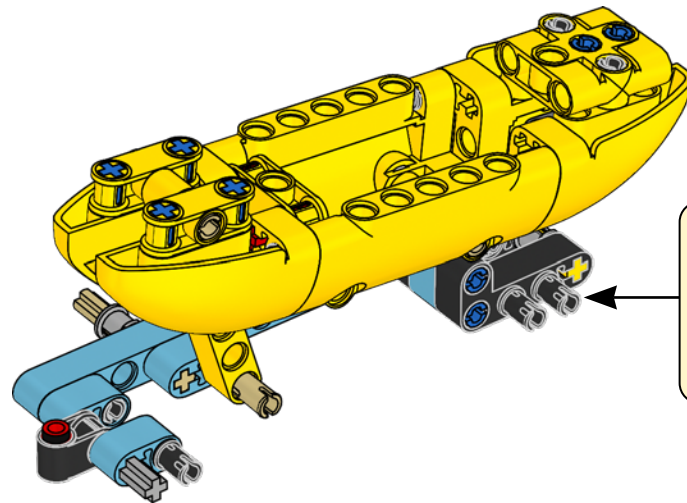
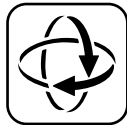

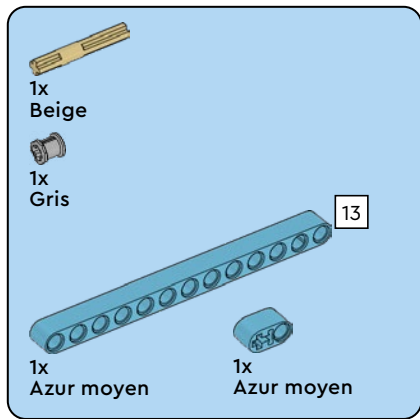

21

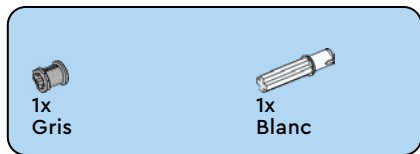
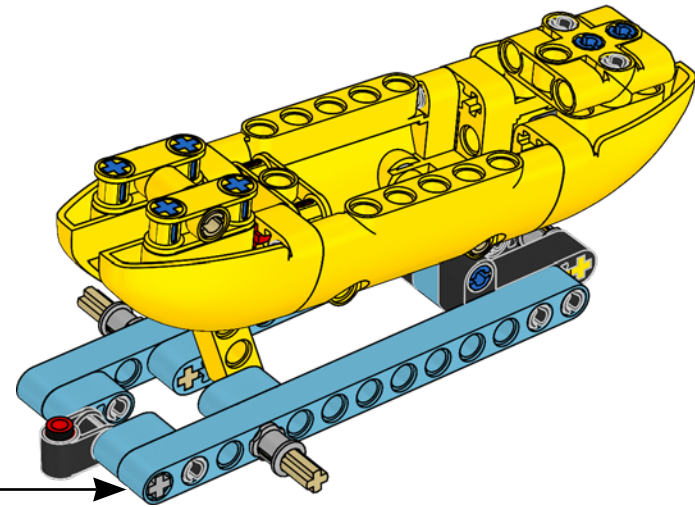
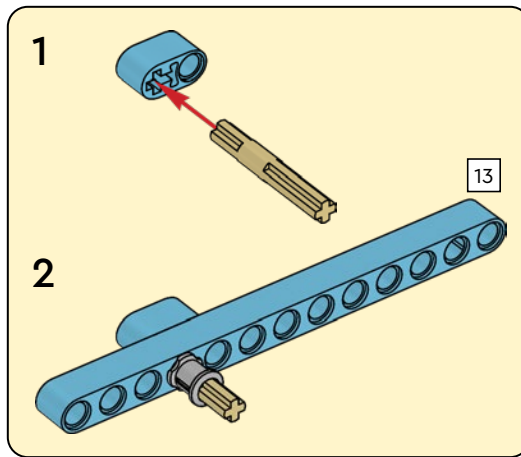

22

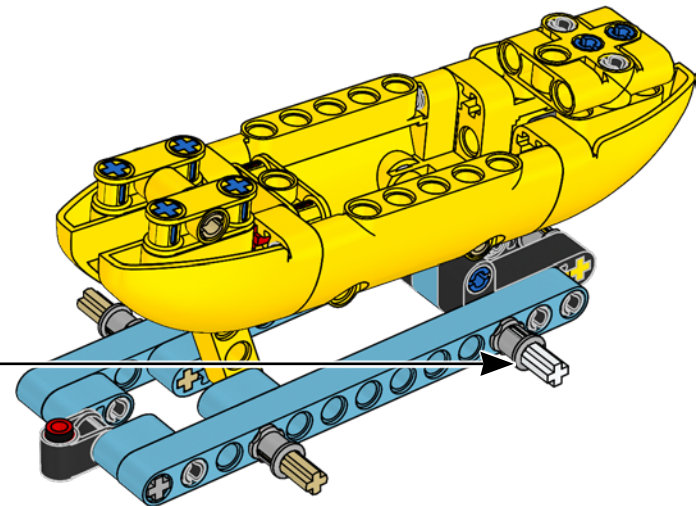
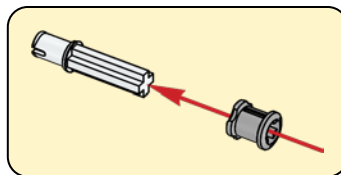

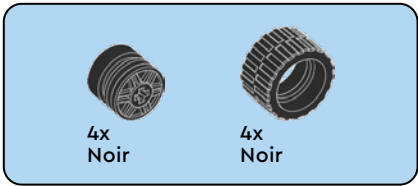

23

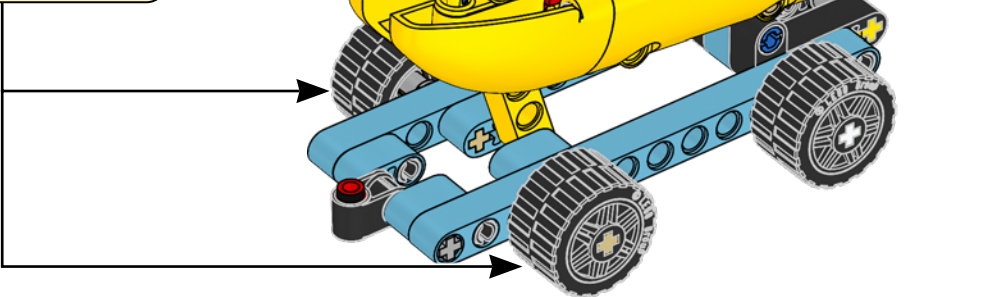
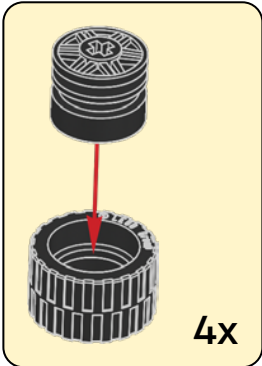

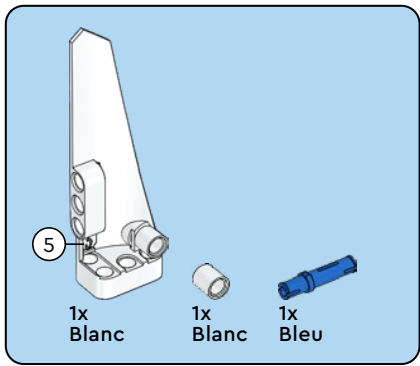

24

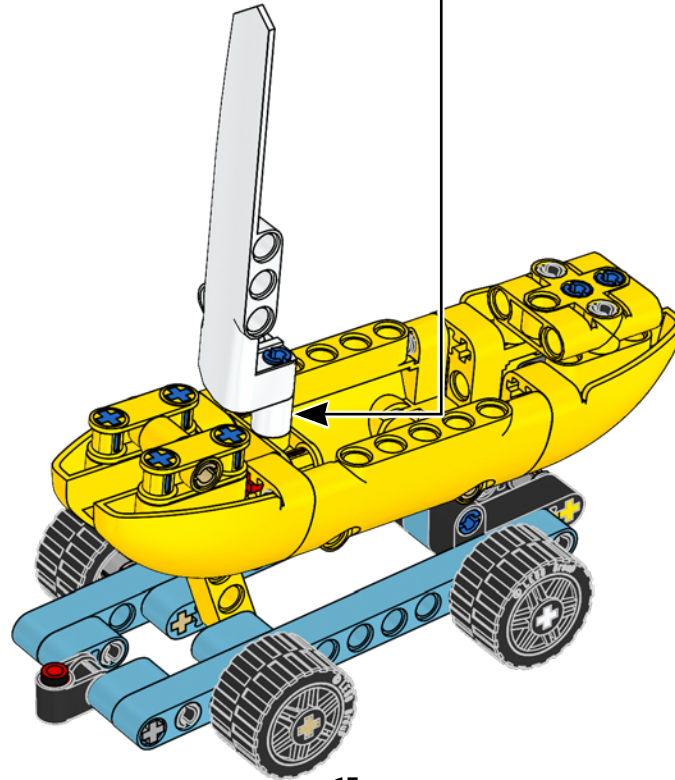
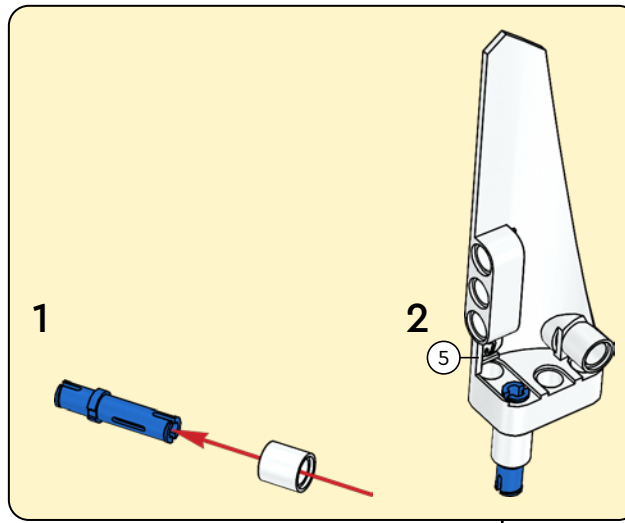

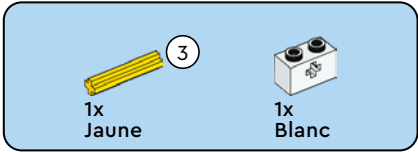
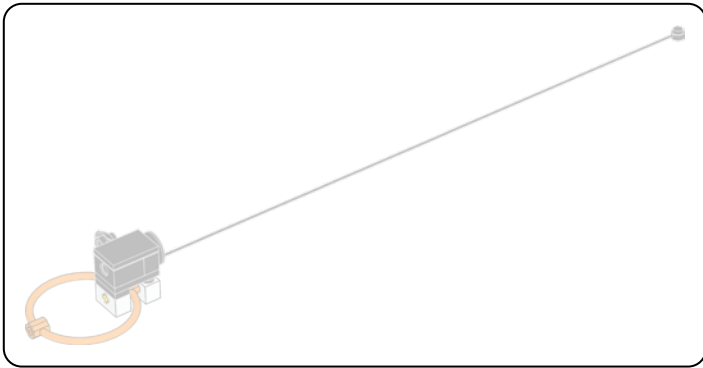

1x
Jaune

1x
Blanc

25

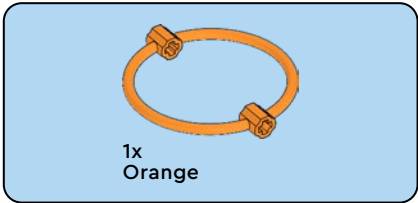
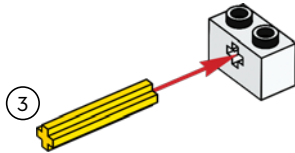

1x
Orange

26

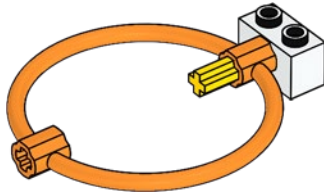



1x
Blanc

27

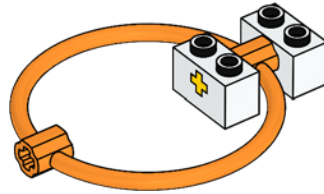

1x
Noir

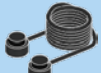

1x
Noir



1x
Noir

28

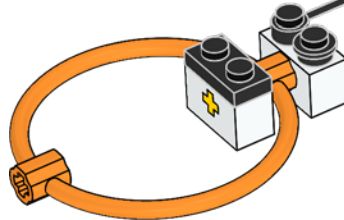

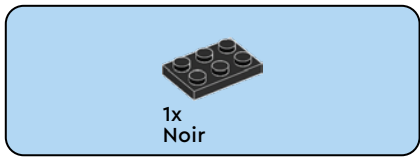

29

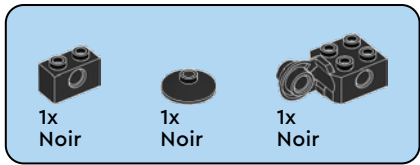
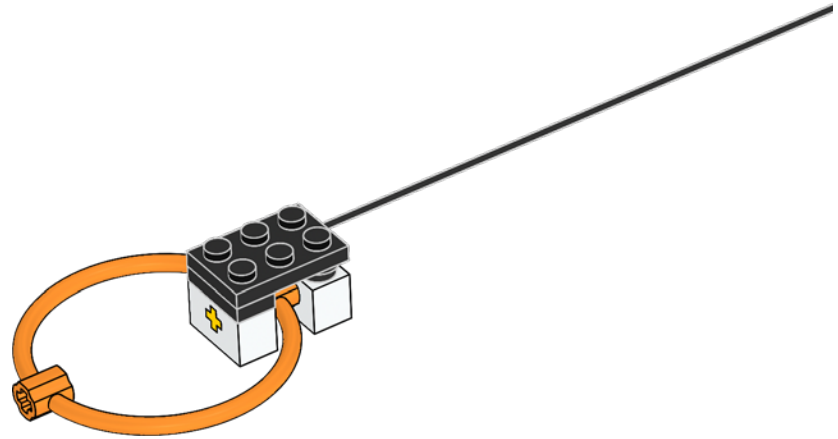

30

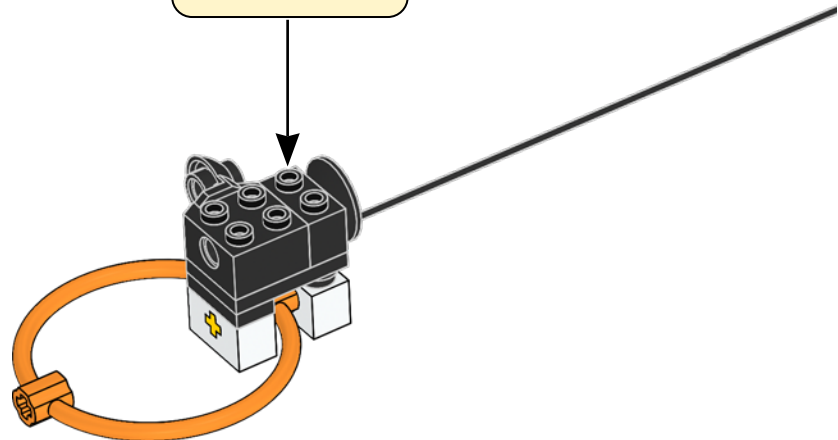
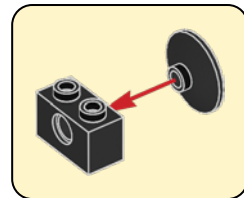

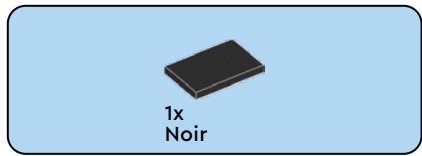

31

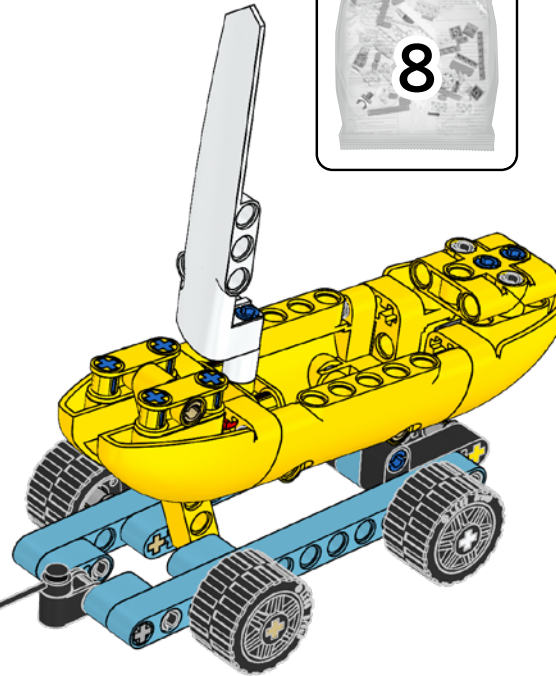
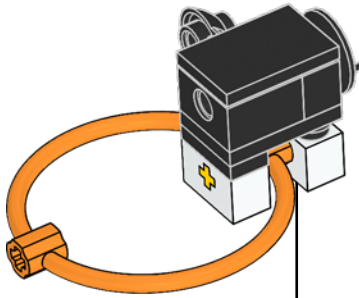

32

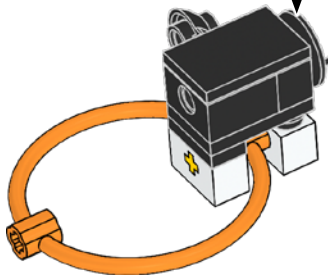

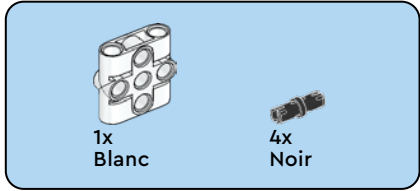
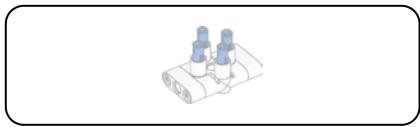

33

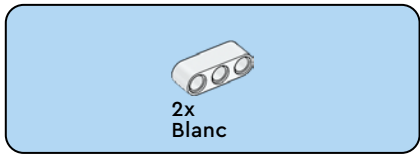
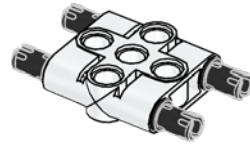

34

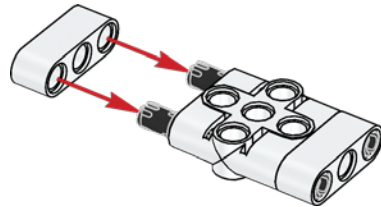

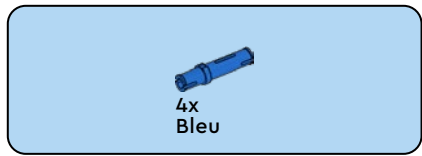

35

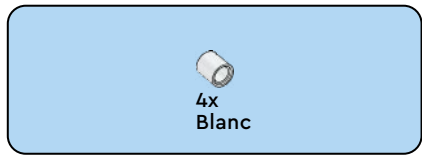
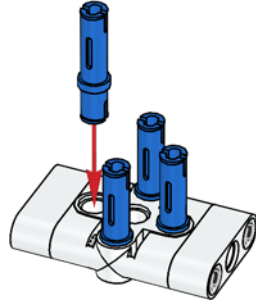

36

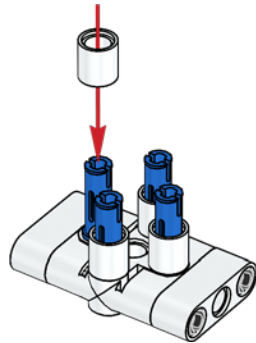

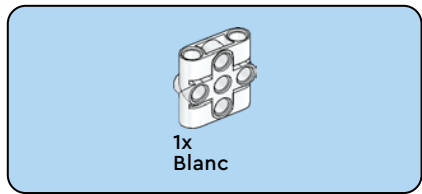

37

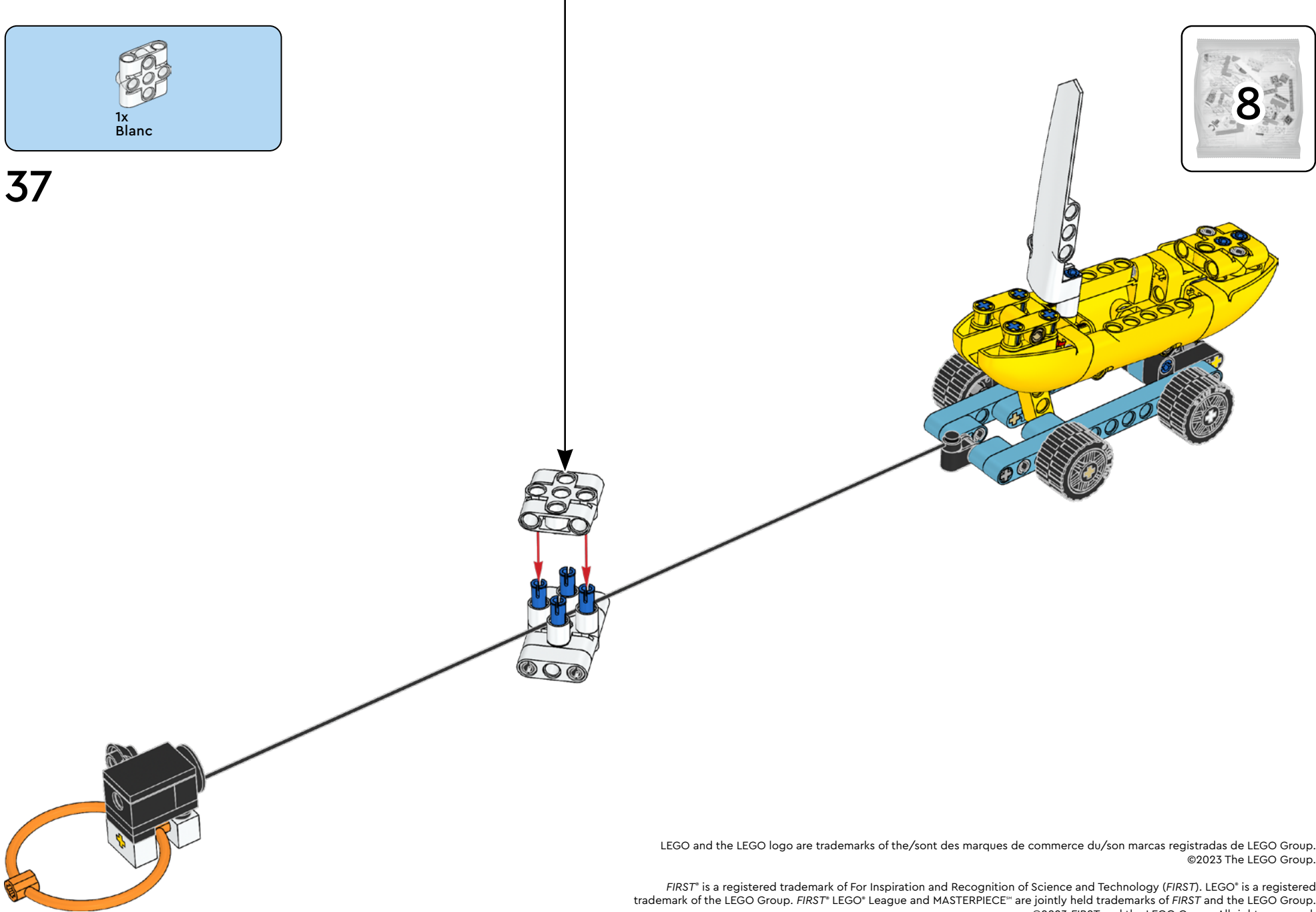

LEGO and the LEGO logo are trademarks of the/son des marques de commerce du/son marcas registradas de LEGO Group.
©2023 The LEGO Group.

FIRST® is a registered trademark of For Inspiration and Recognition of Science and Technology (FIRST). LEGO® is a registered trademark of the LEGO Group. FIRST® LEGO® League and MASTERPIECE™ are jointly held trademarks of FIRST and the LEGO Group.
©2023 FIRST and the LEGO Group. All rights reserved.