

45816

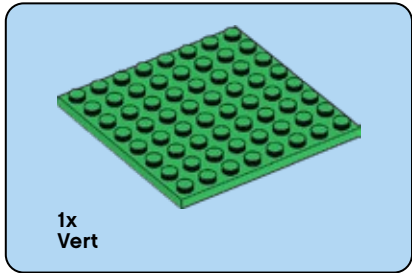

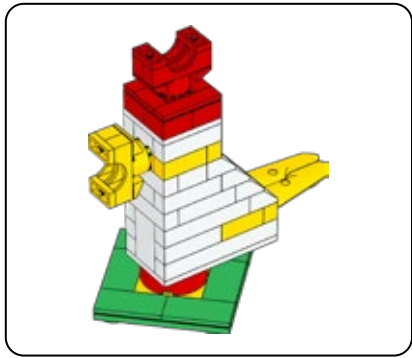

1

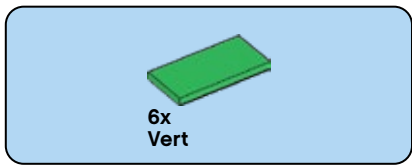
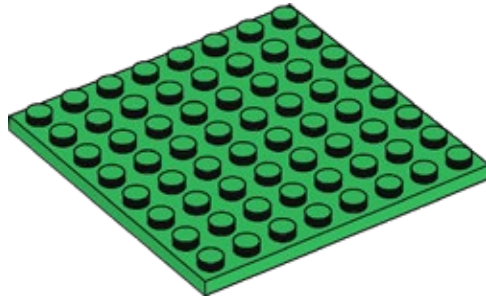

2

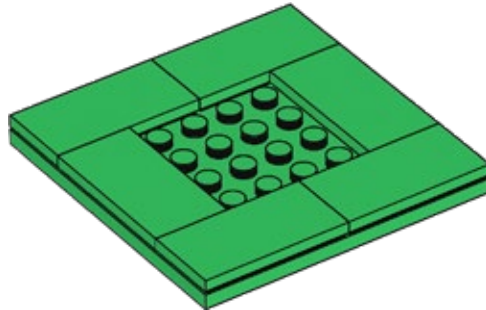

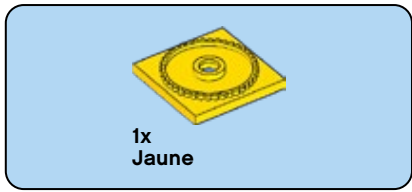

3



4

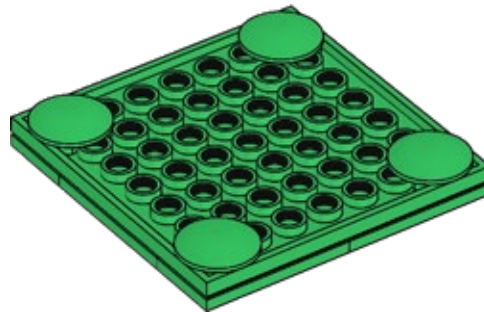
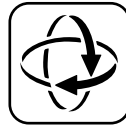

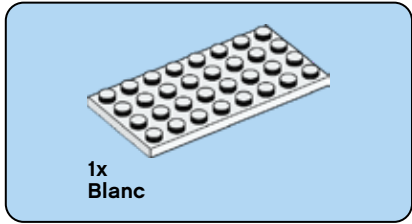
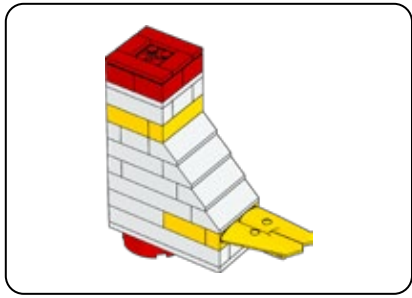

5

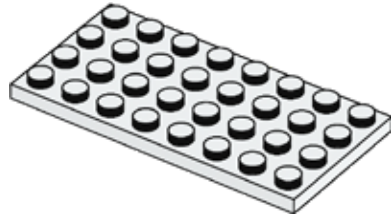

6

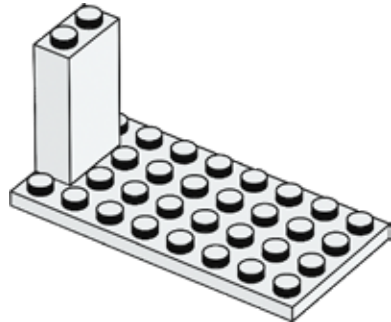

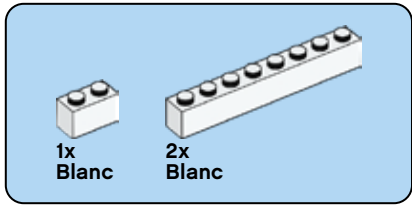

7

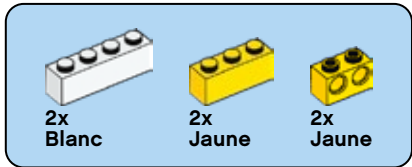
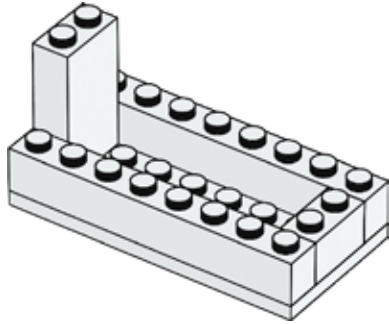

8

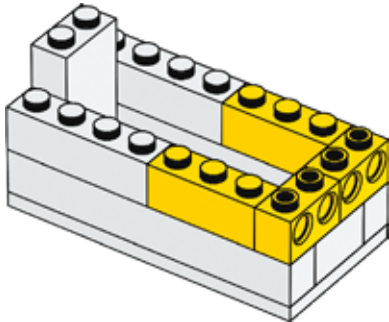

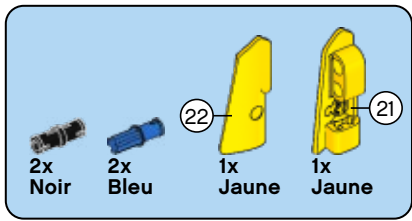

9

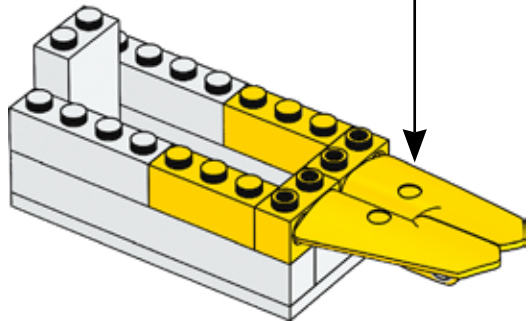
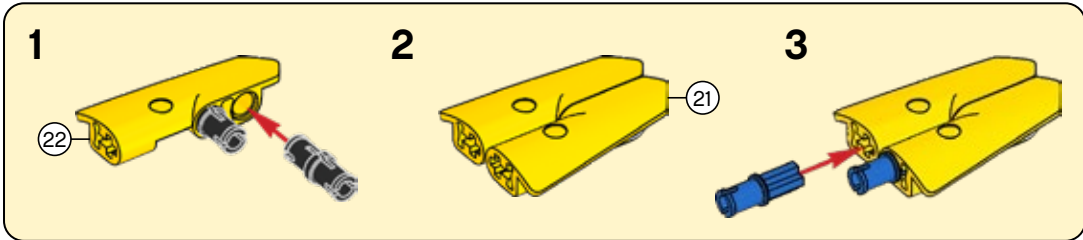

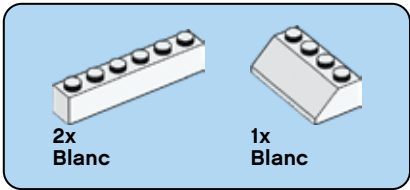

10

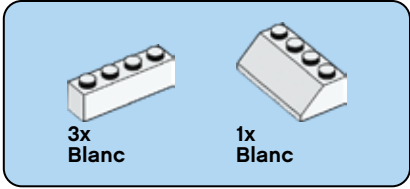
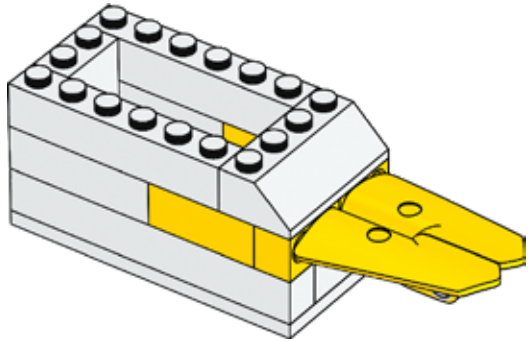

11

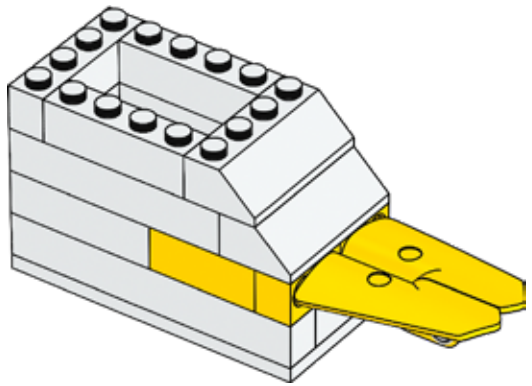

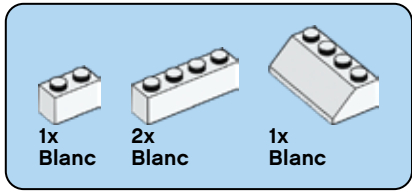

12

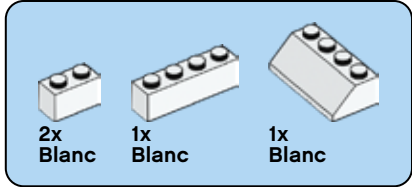
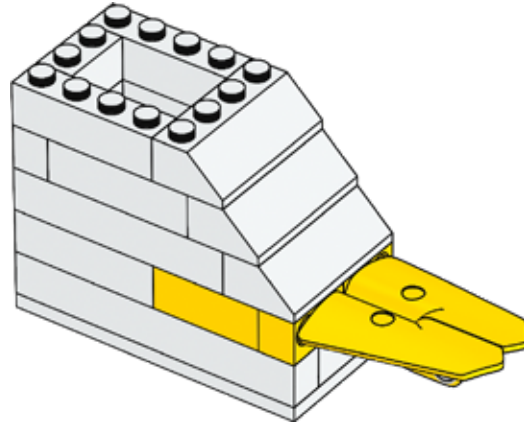

13

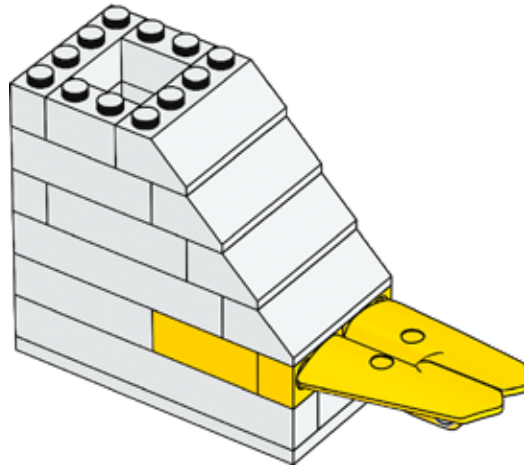



1x
Jaune

14

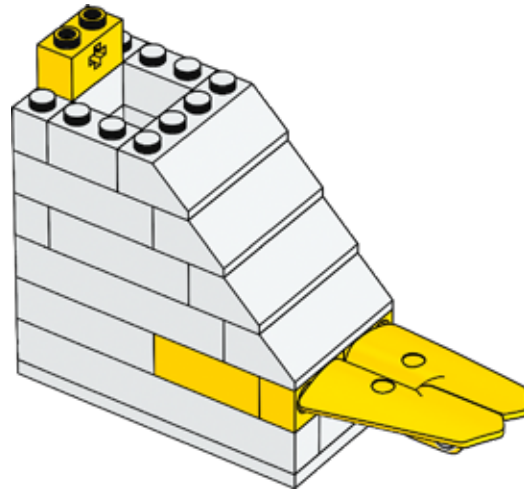

1x
Jaune



2x
Jaune

15

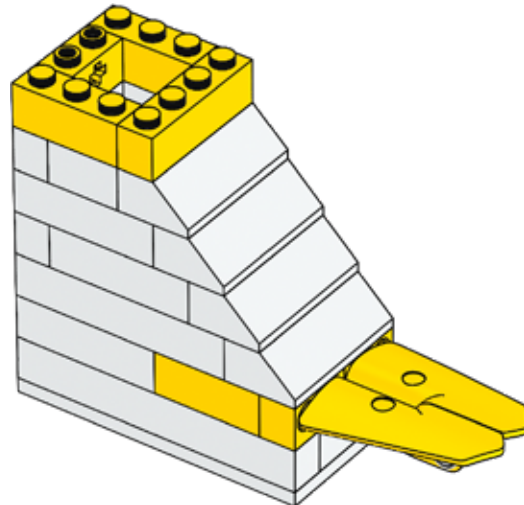

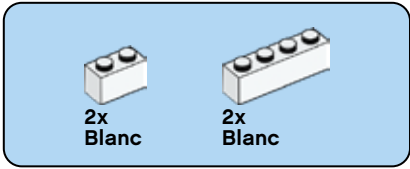

16

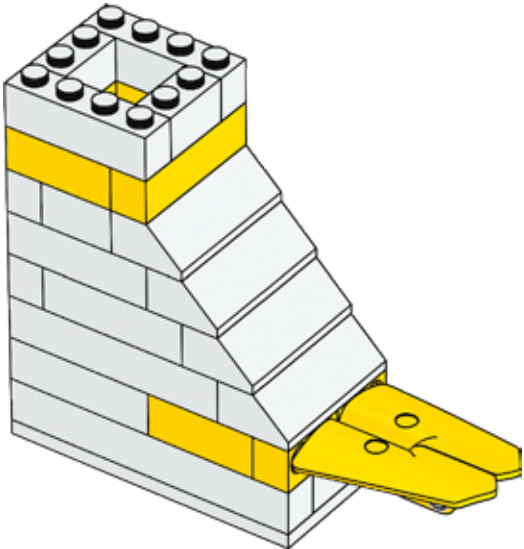

17

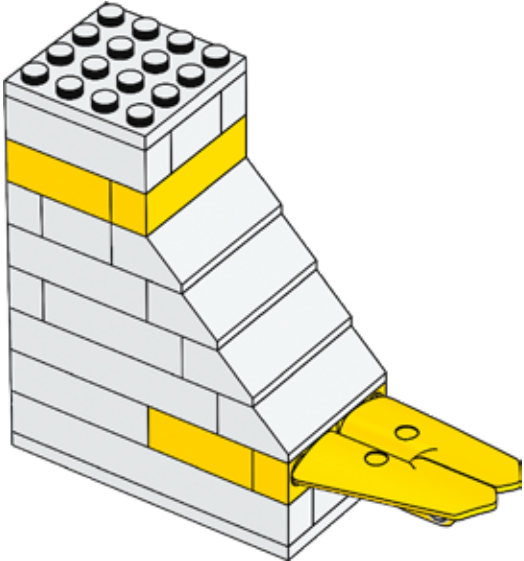



1x
Rouge

18

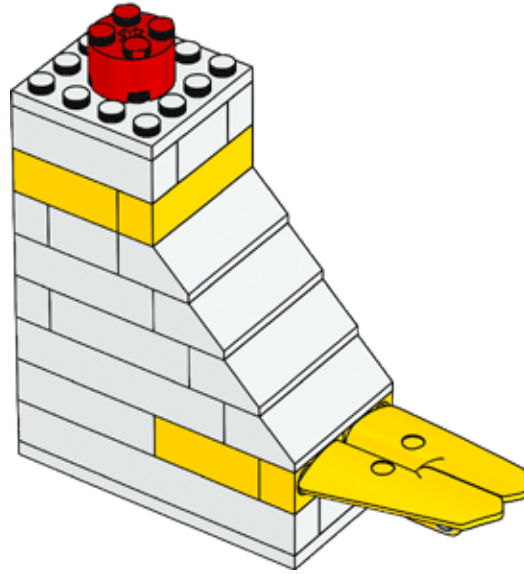

5



4x
Rouge

19

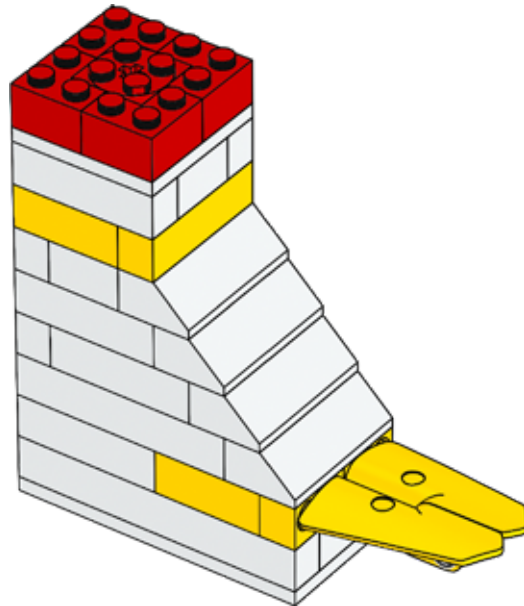

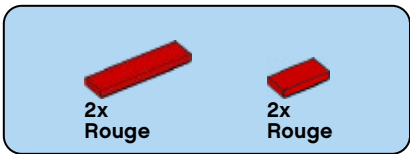

20

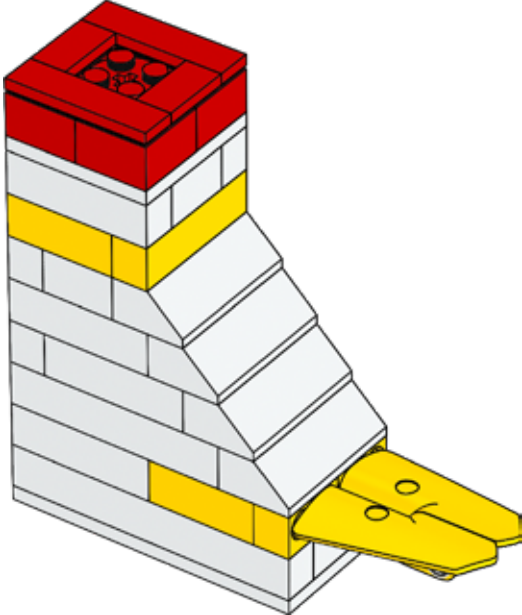



21

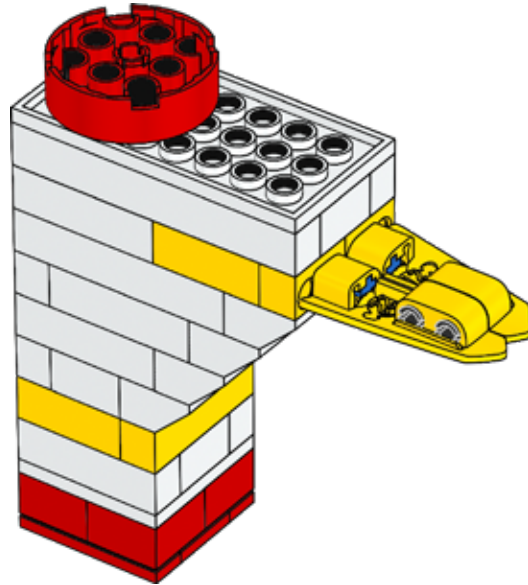

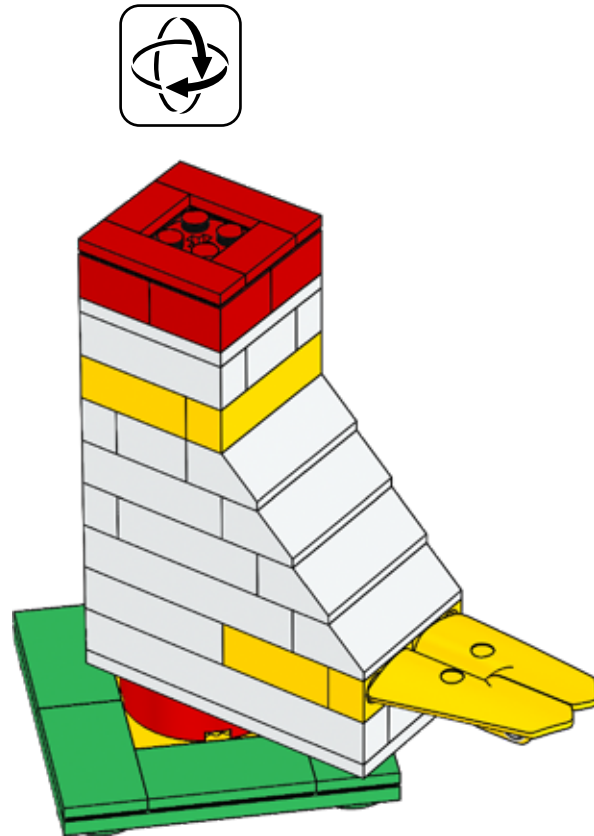

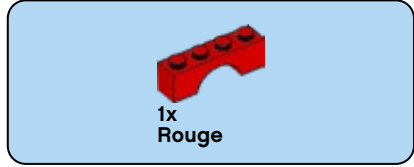
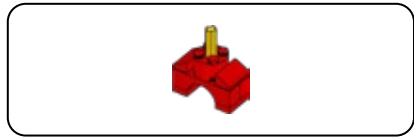

23

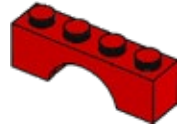

24

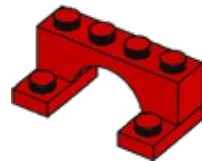

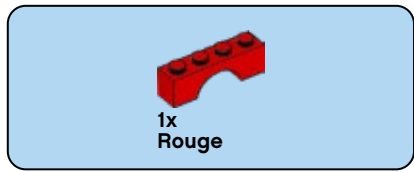

25

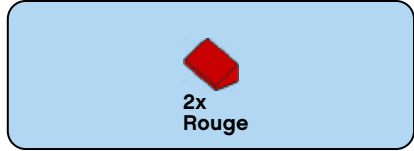
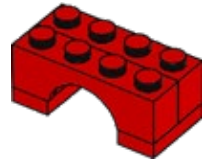

26

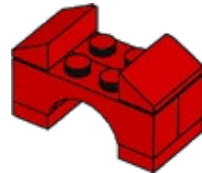



1x
Rouge

27

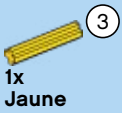
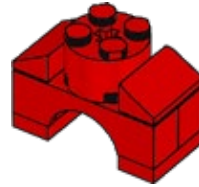

1x
Jaune

28

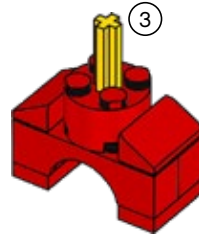

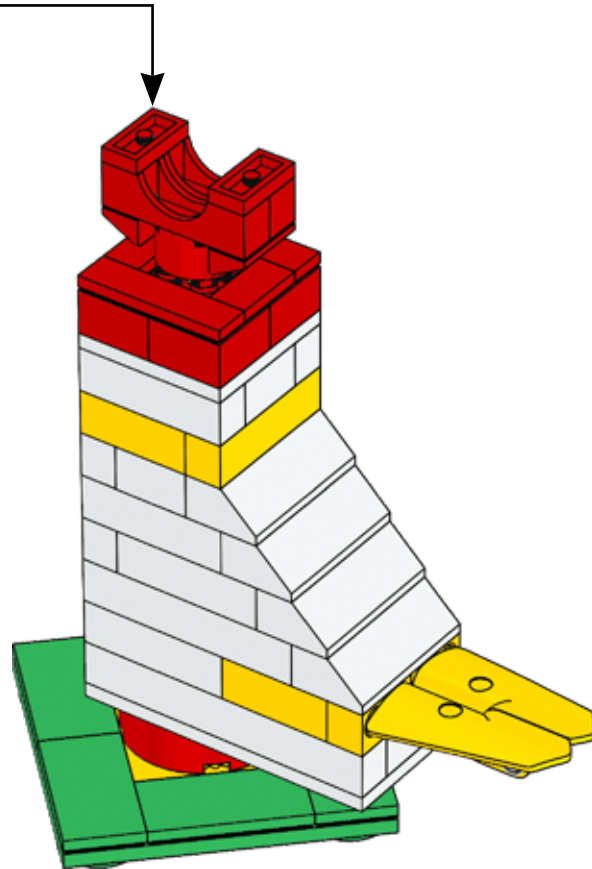

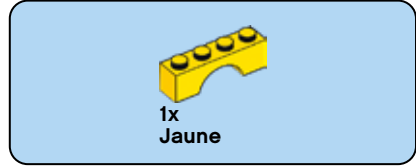
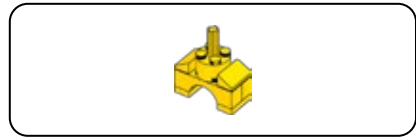

30

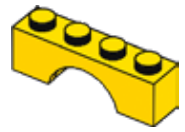

31

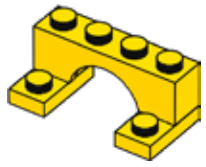

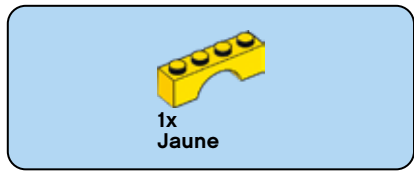

32

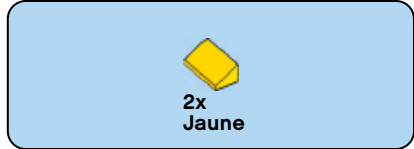
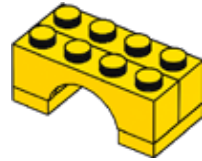

33





1x
Jaune

34

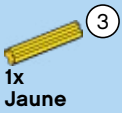
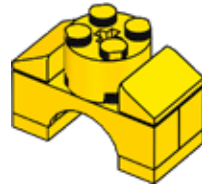

1x
Jaune

35

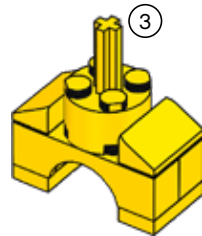

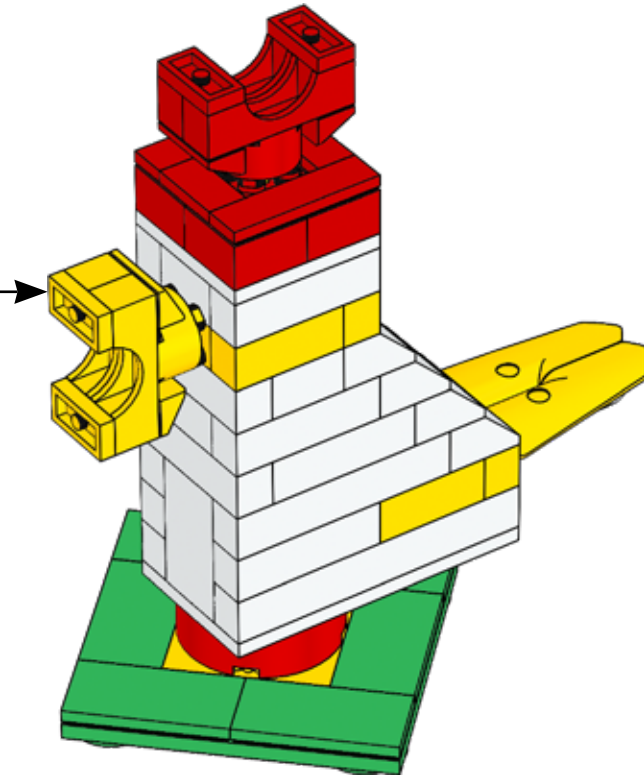

LEGO and the LEGO logo are trademarks of the/son des marques de commerce du/son marcas registradas de LEGO Group. ©2021 The LEGO Group. All rights reserved/Tous droits réservés/Todos los derechos reservados.

FIRST® is a registered trademark of For Inspiration and Recognition of Science and Technology (FIRST). LEGO® is a registered trademark of the LEGO Group. FIRST® LEGO® League and CARGO CONNECT™ are jointly held trademarks of FIRST and the LEGO Group.

©2021 FIRST and the LEGO Group. All rights reserved.