

1

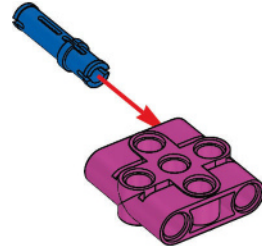



1x

2

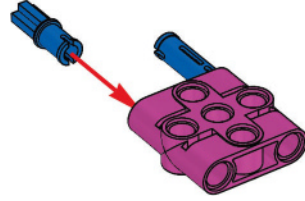

15

1x

3

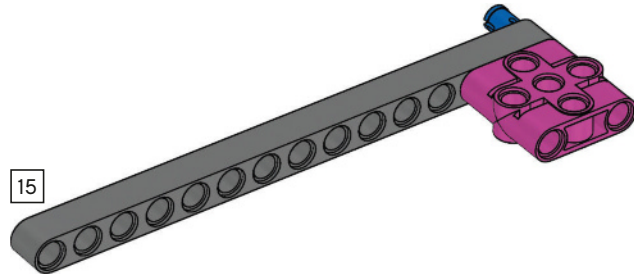

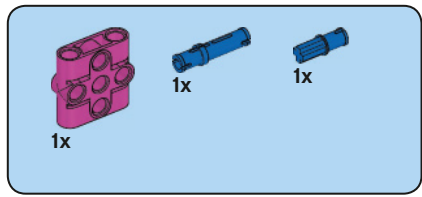

4

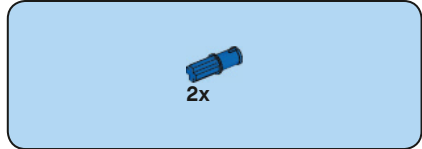
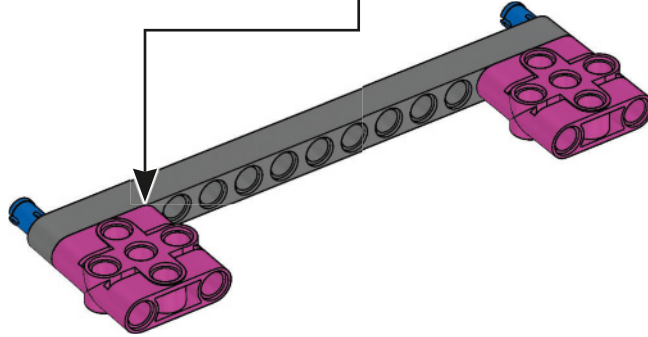
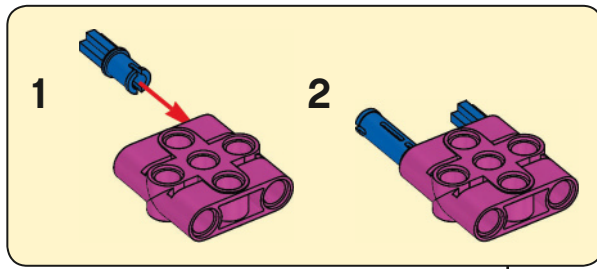

5

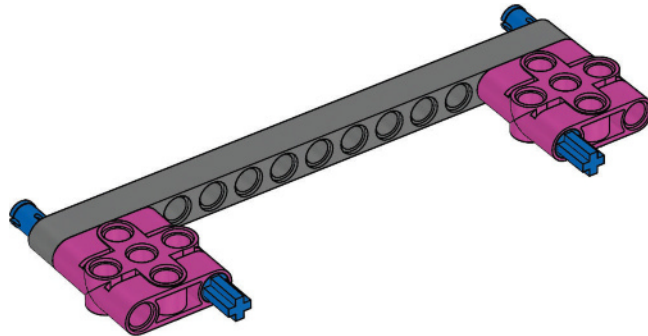



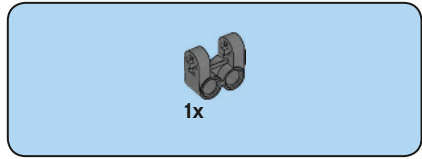
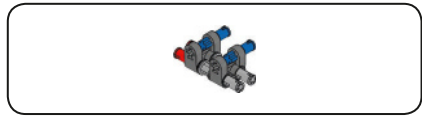

6

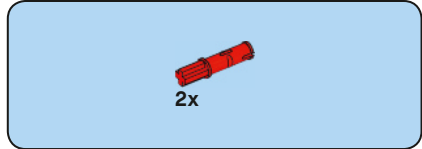
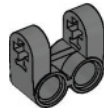

7

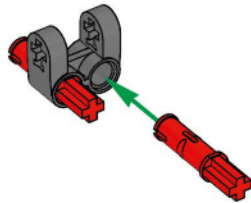

8

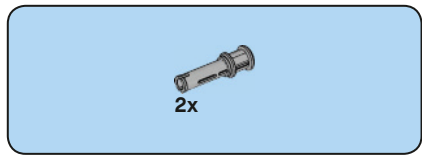

8

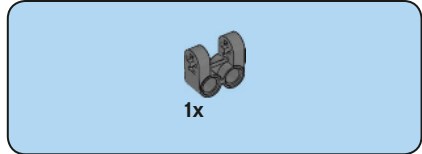
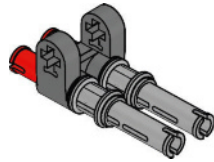

9

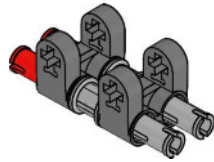



10

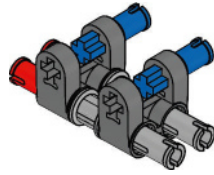

11

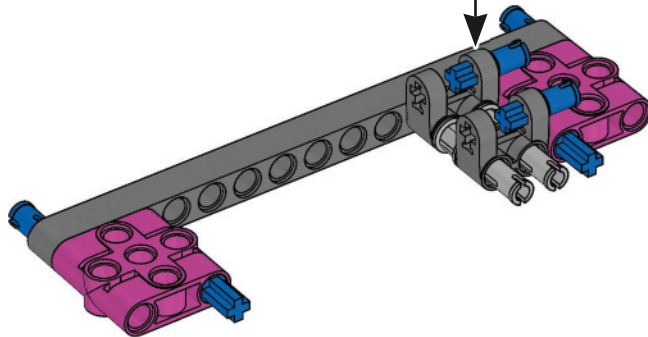

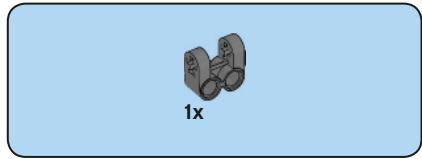
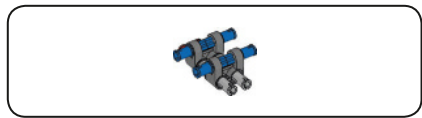

12

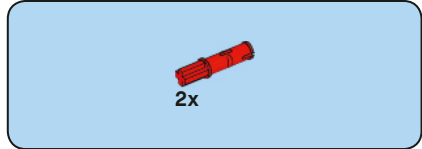
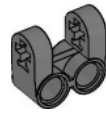

13

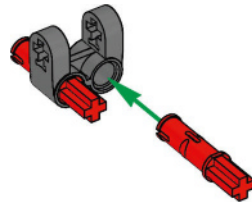

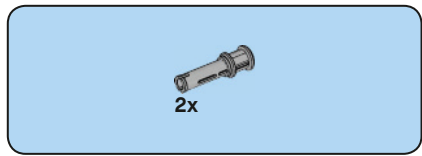

14

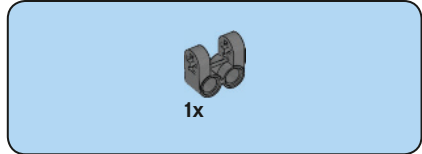
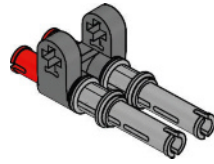

15

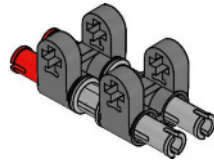



4x

16

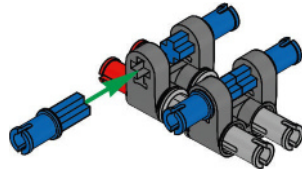

17

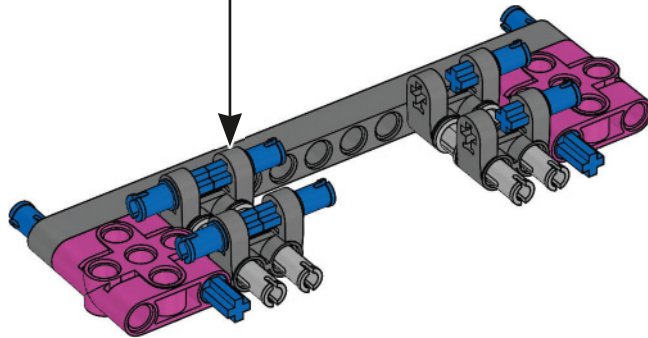

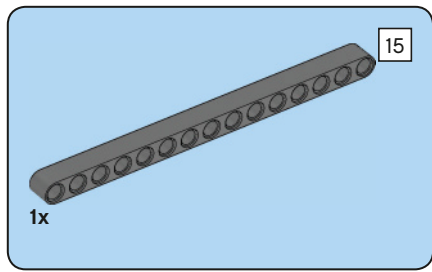

18

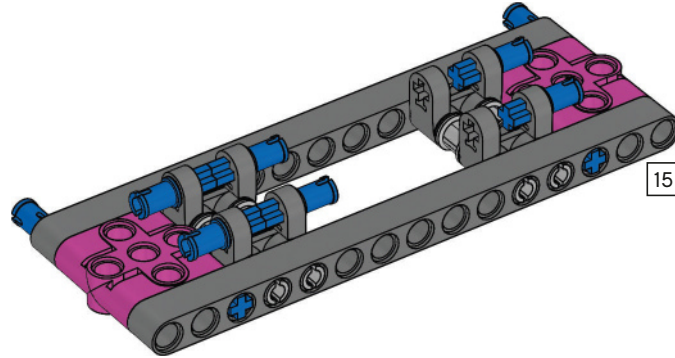

19

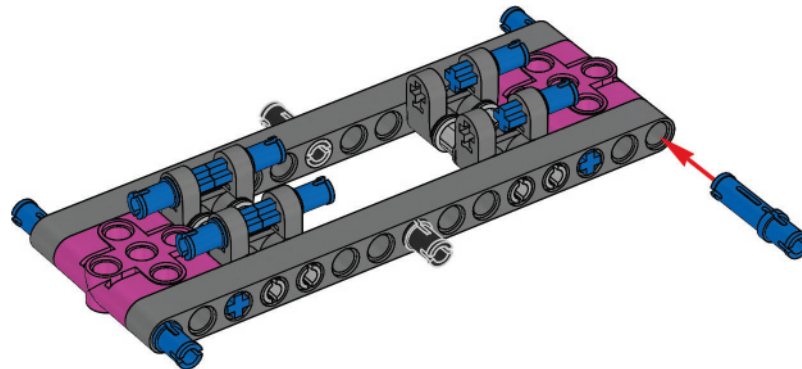

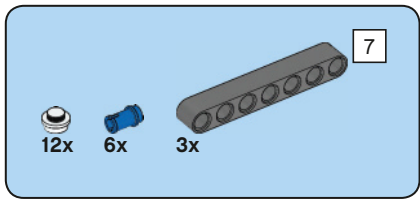

20

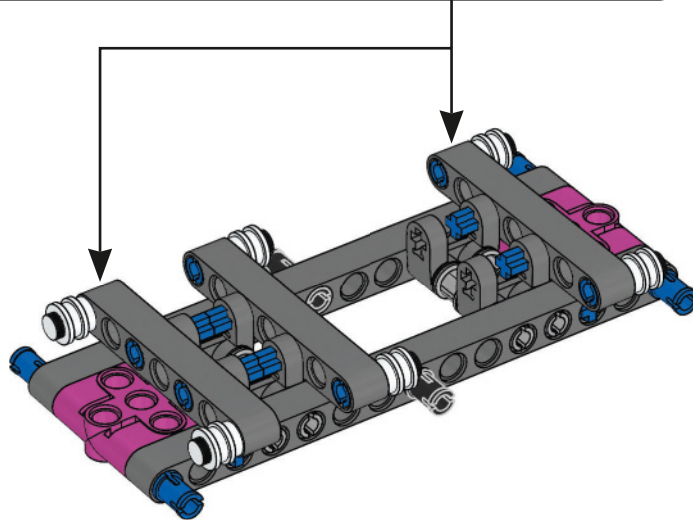
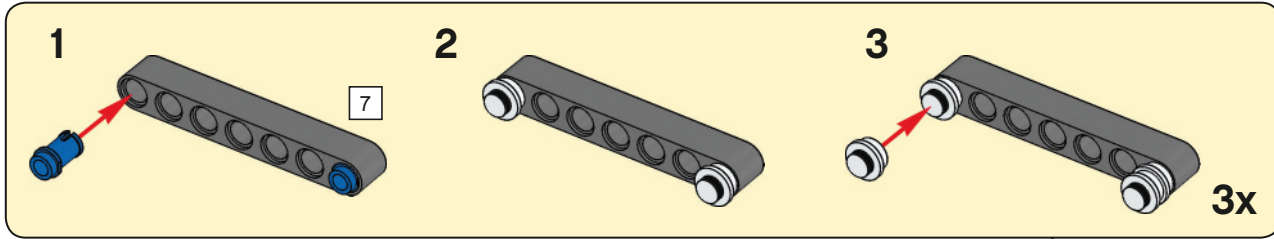



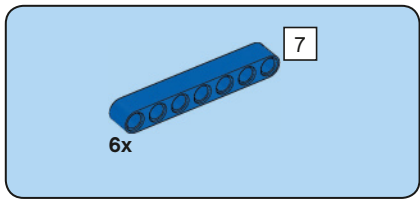

21

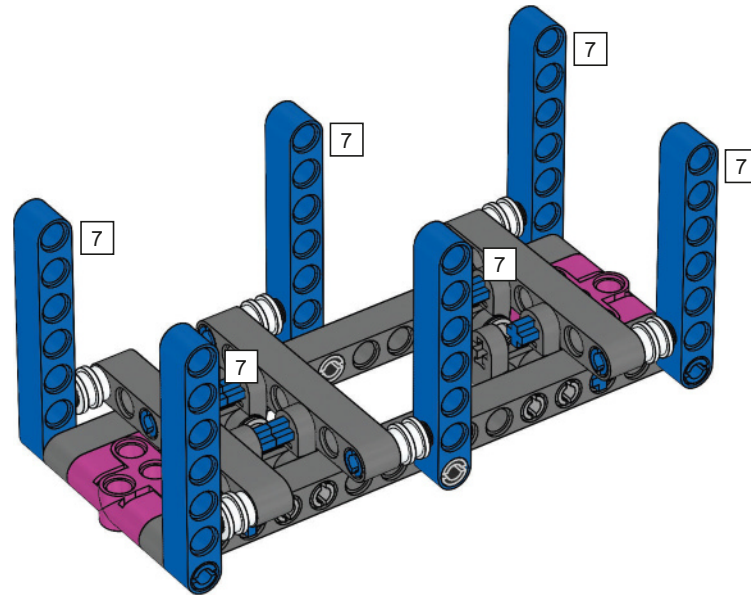

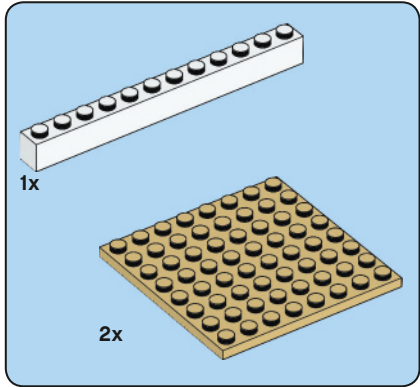
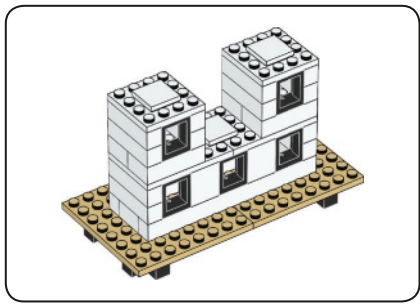

22

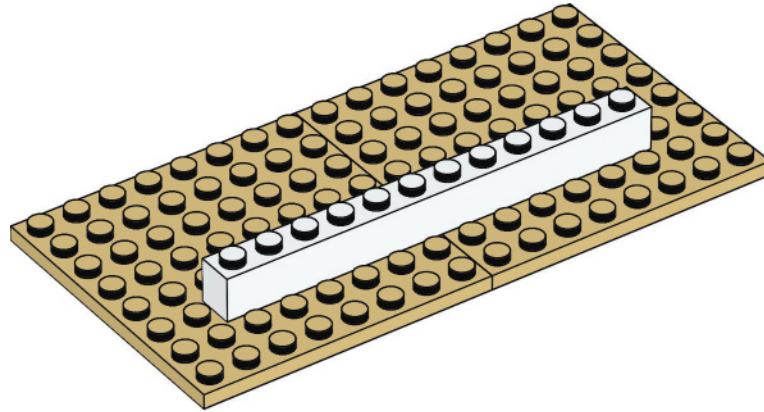

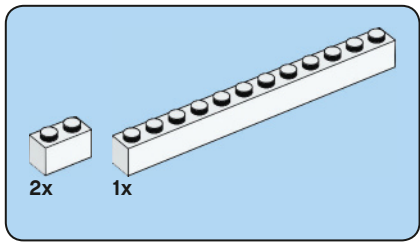

23

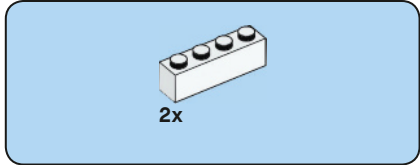
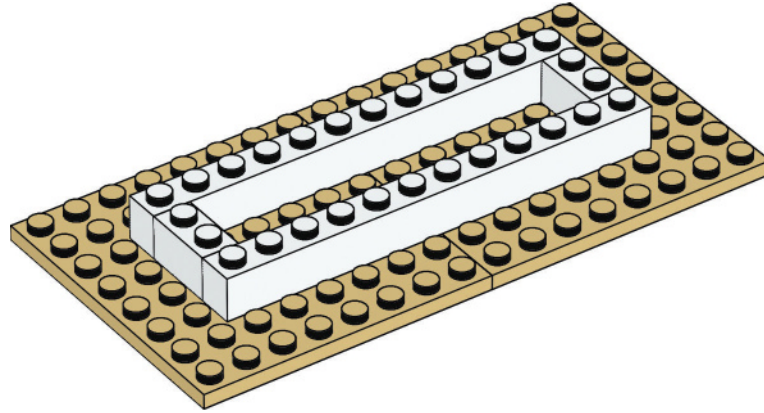

24

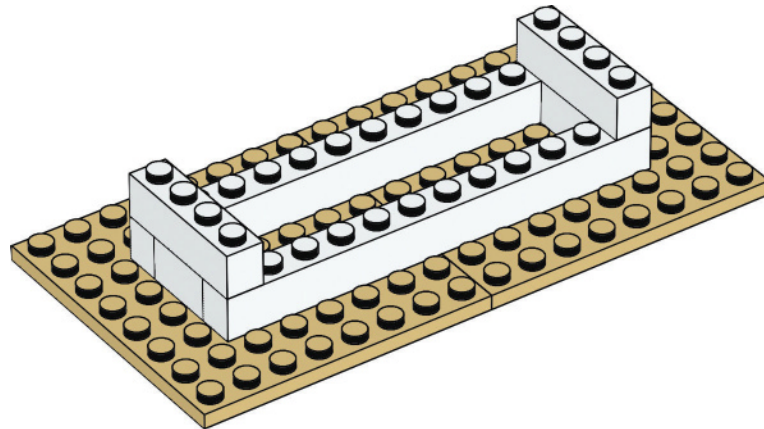

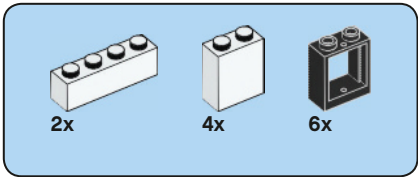

25

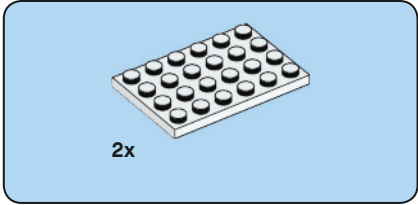
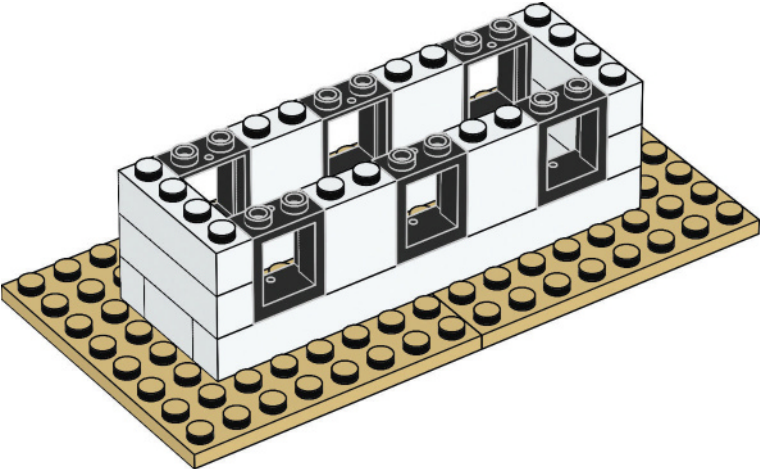

26

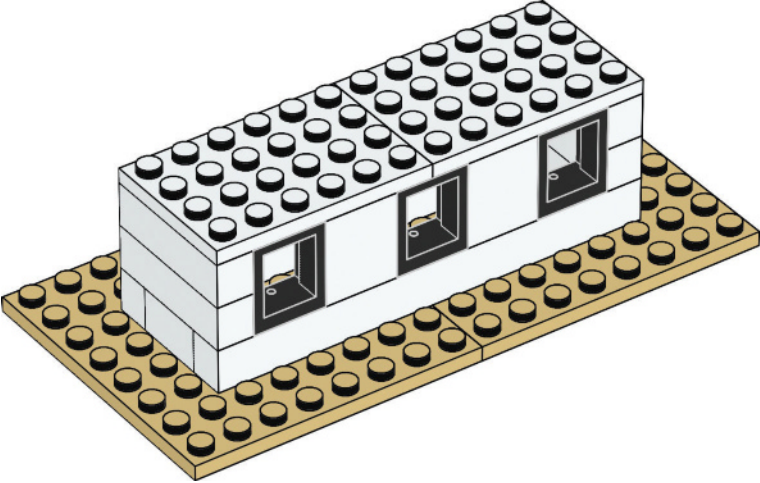

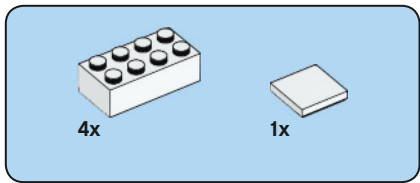

27

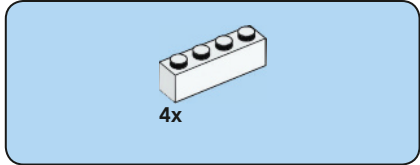
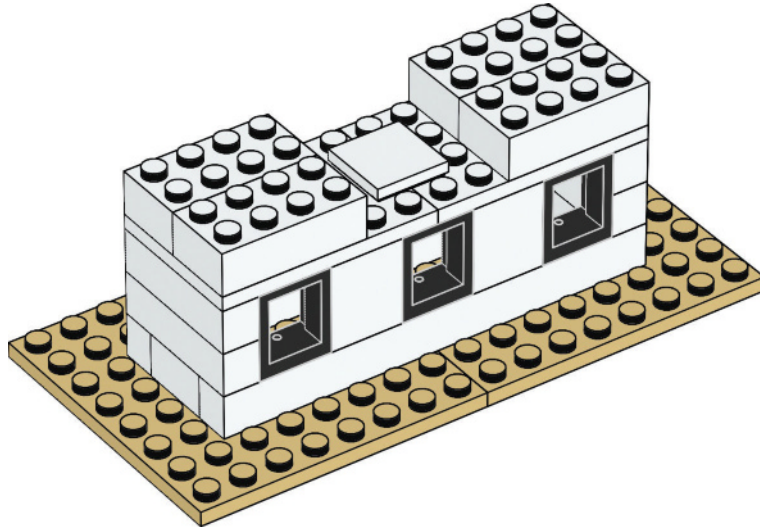

28

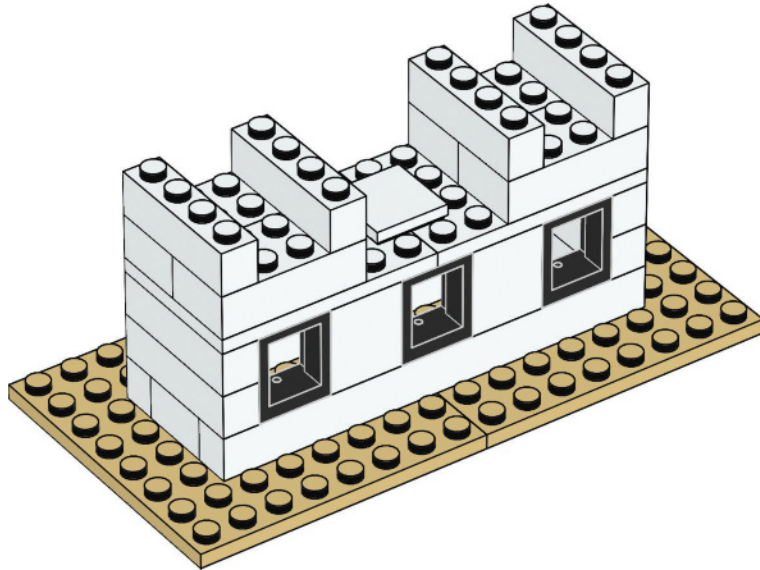

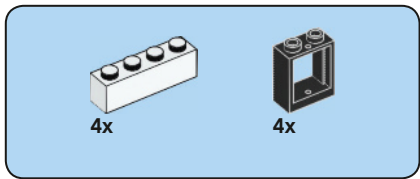

29

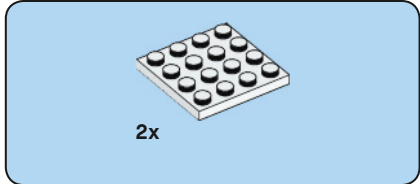
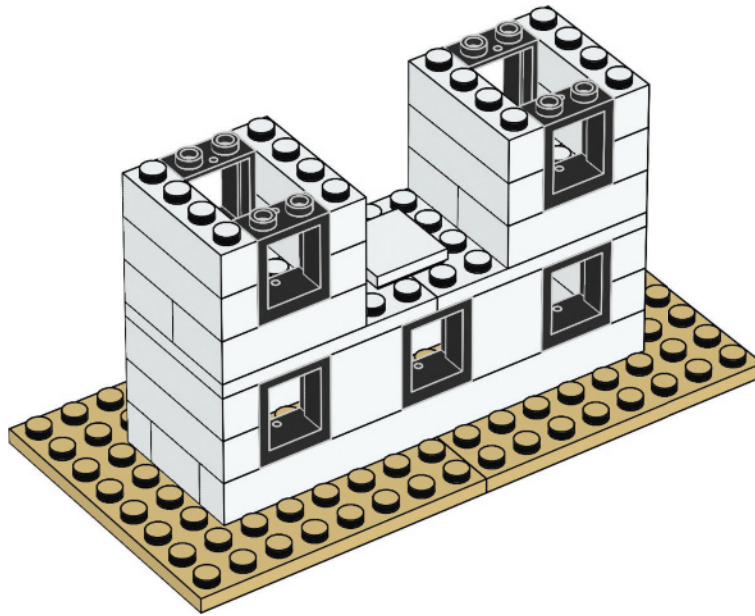

30

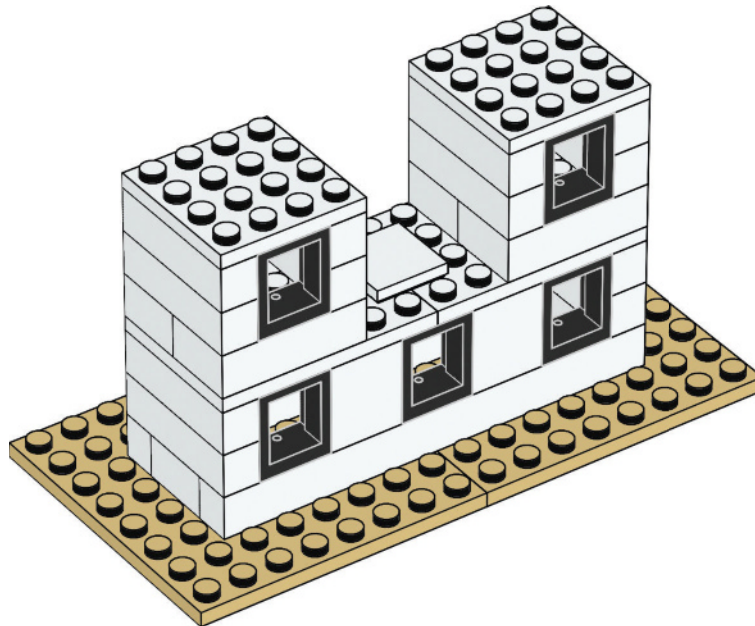



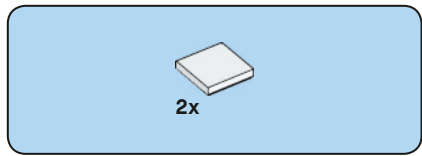

31

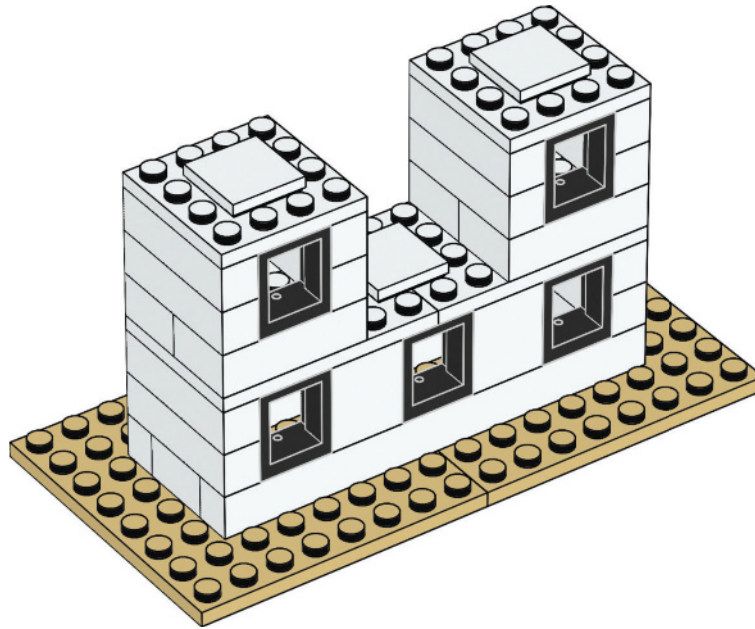

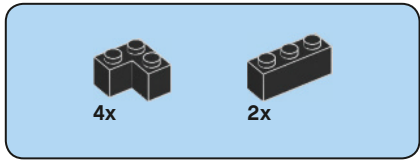

32

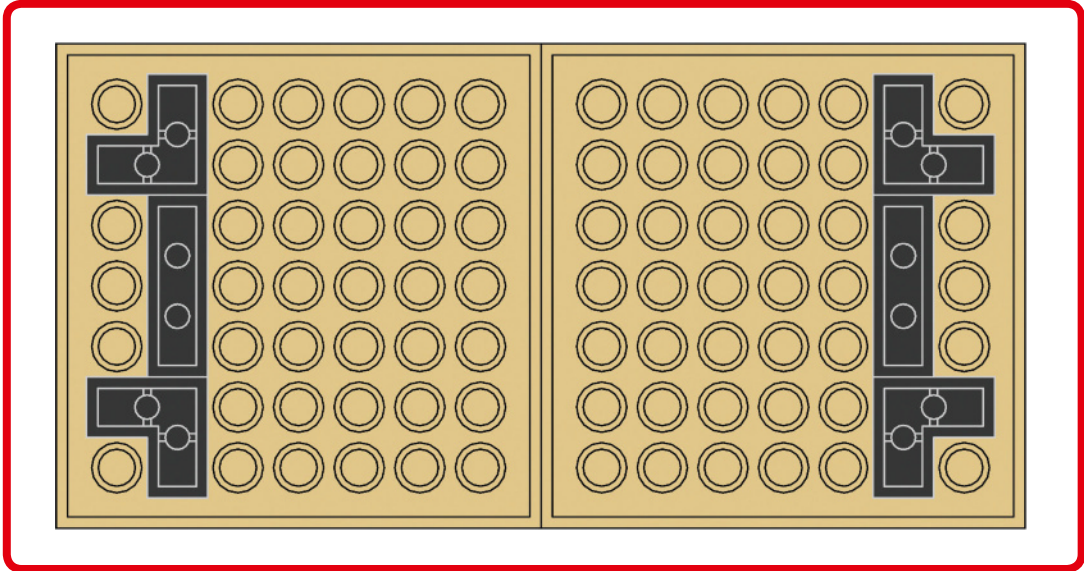
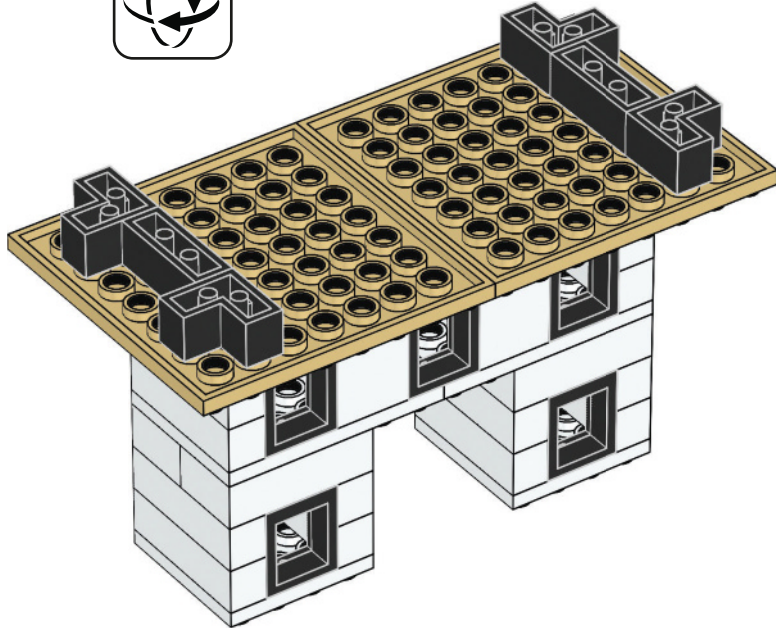



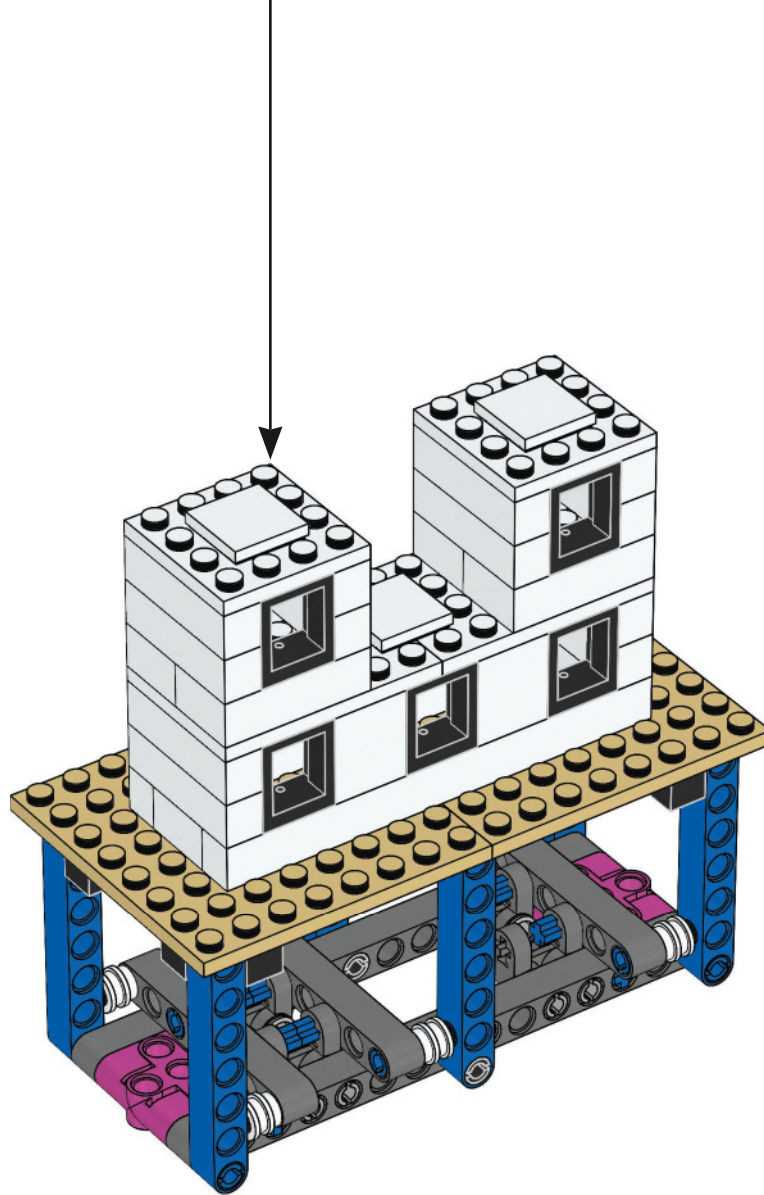

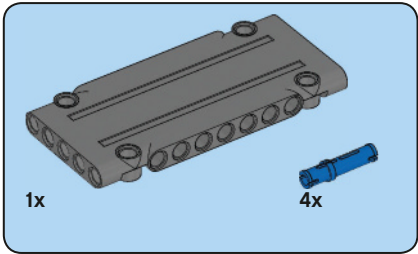
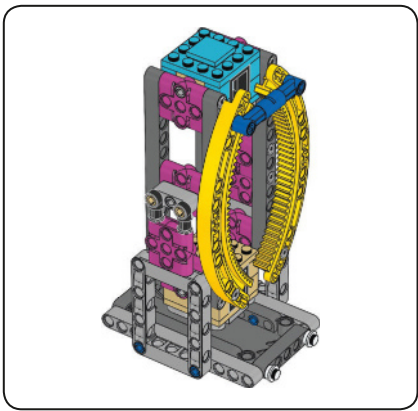

34

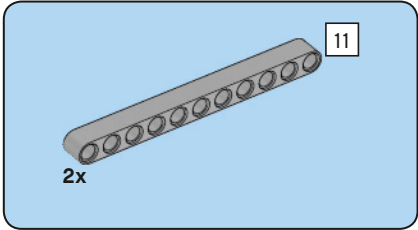
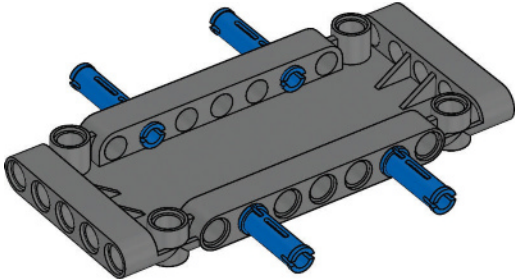

35

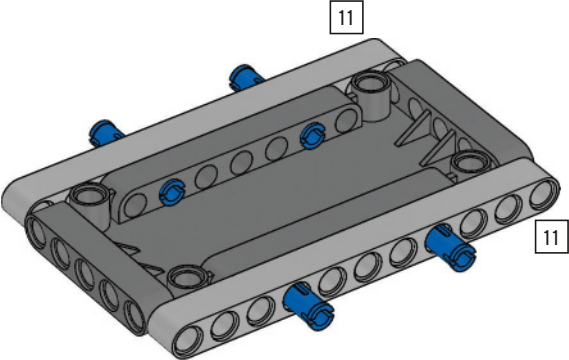



2x

36

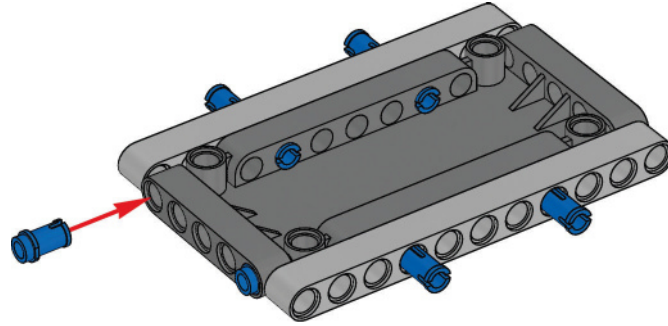

2x

37

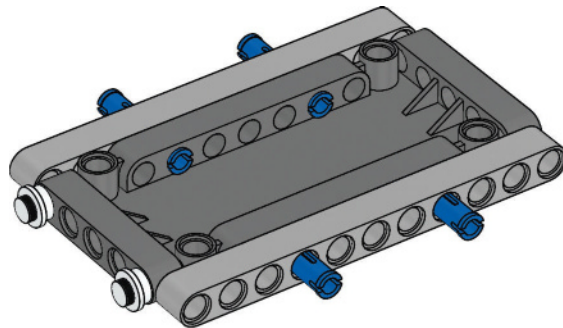

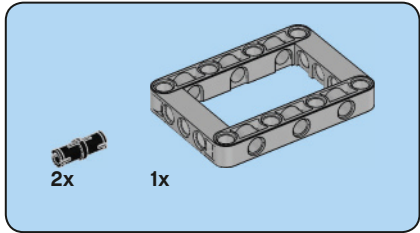
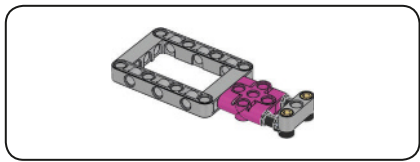

38

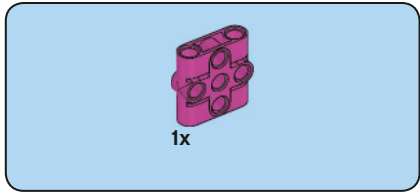
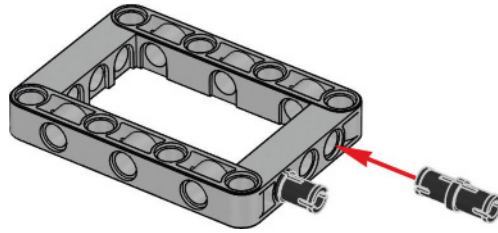

39

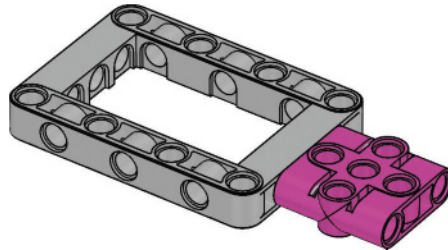

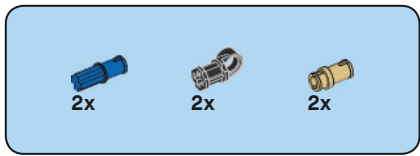

40

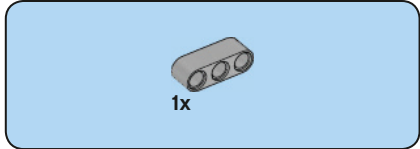
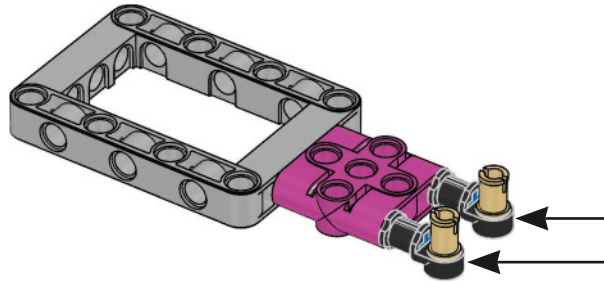
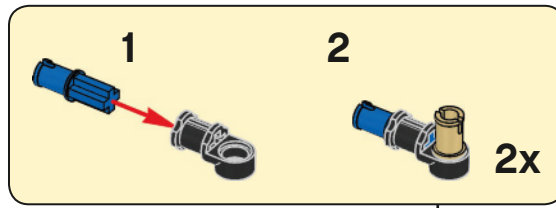

41

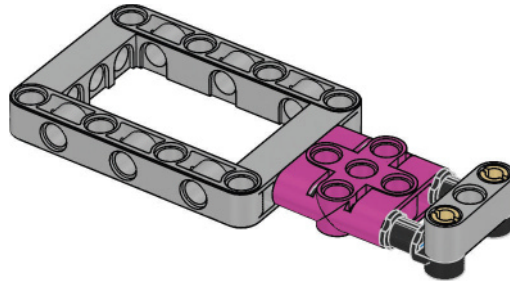

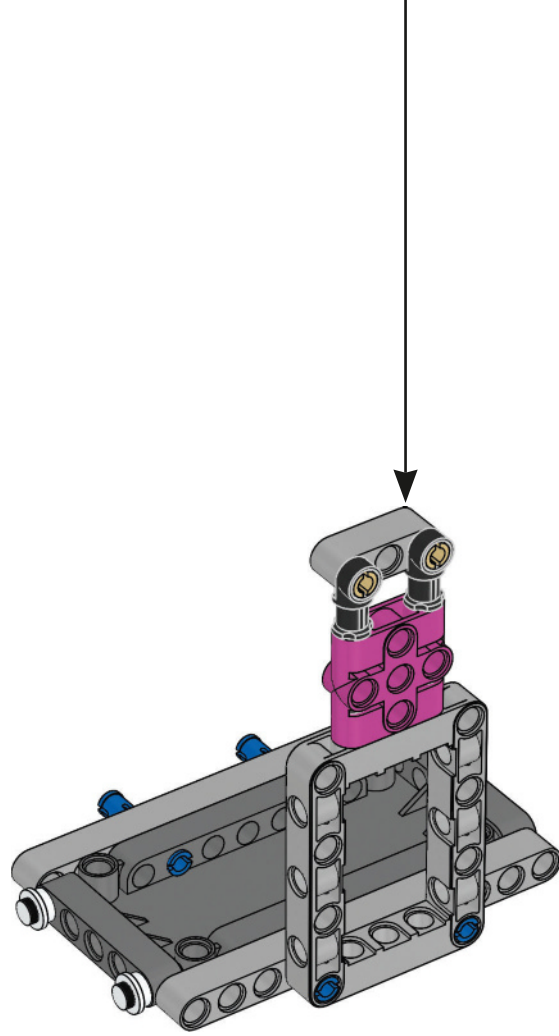

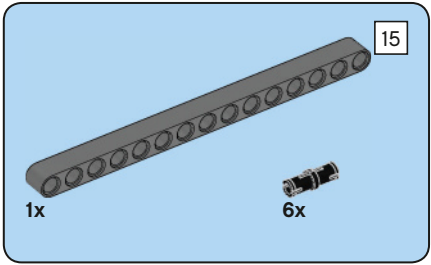
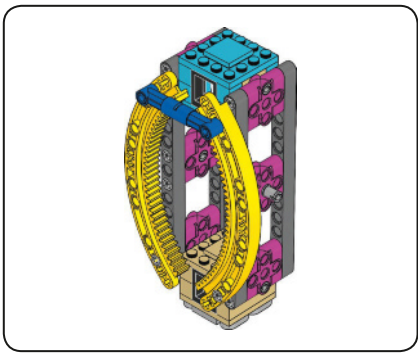

43

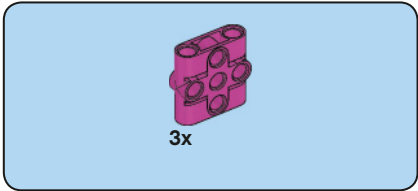
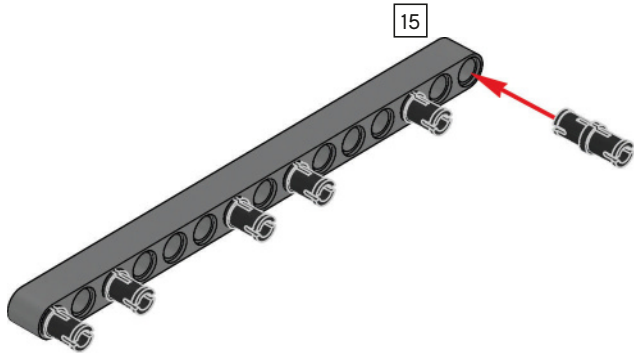

44

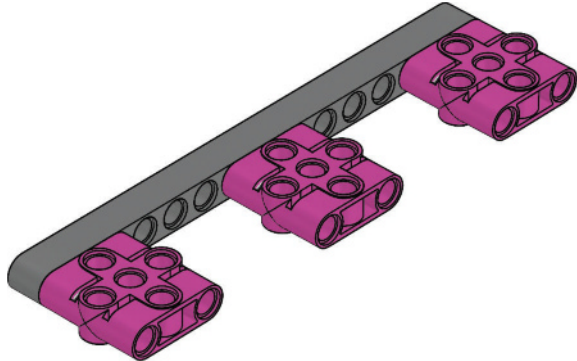



6x

45

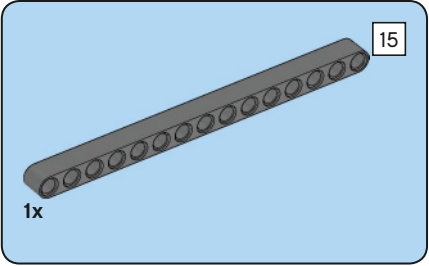
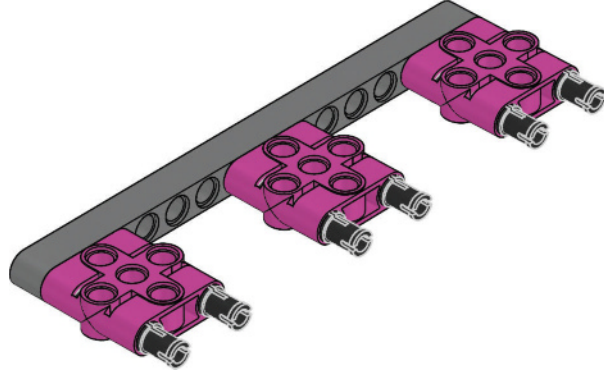

15

1x

46

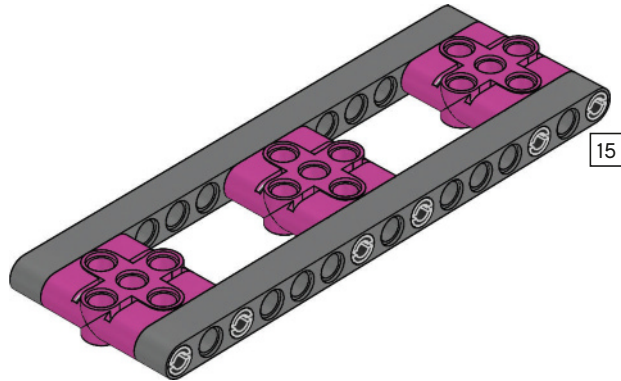

15



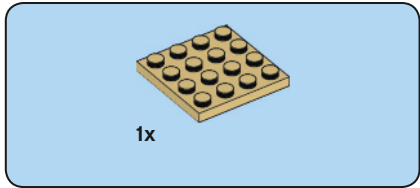
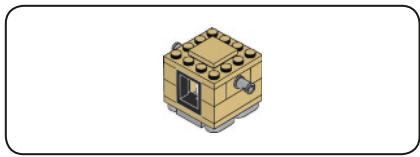

47

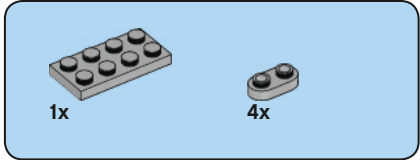
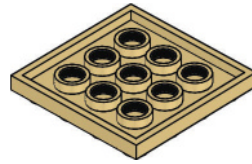

48

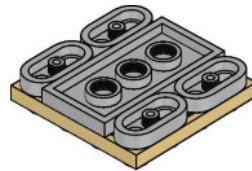

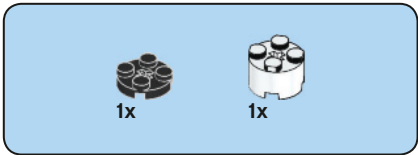

49

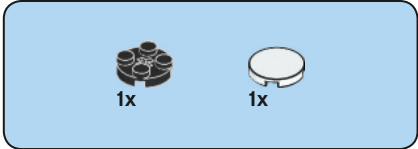
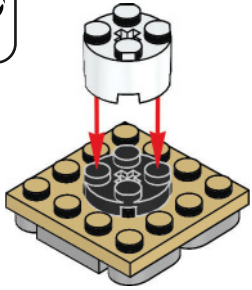

50

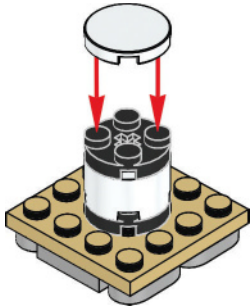

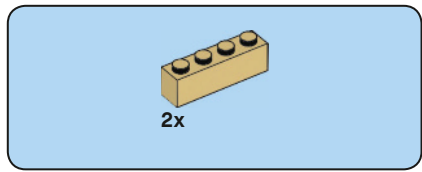

51

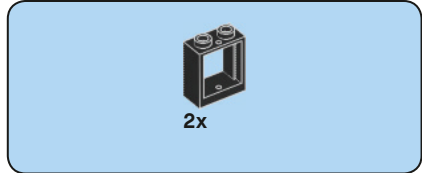
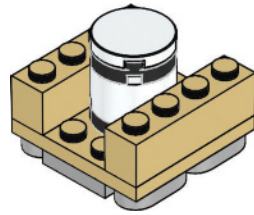

52

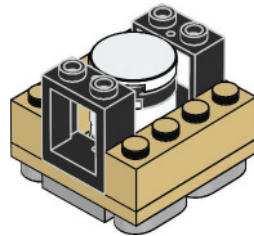

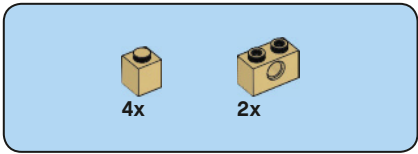

53

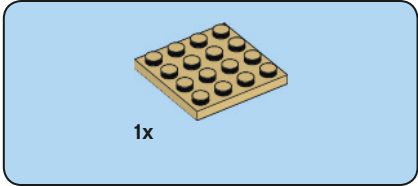
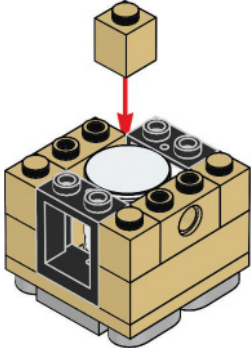

54

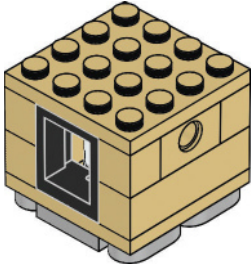

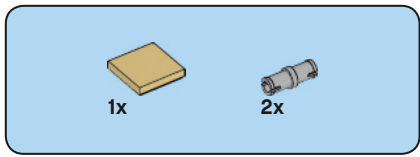

55

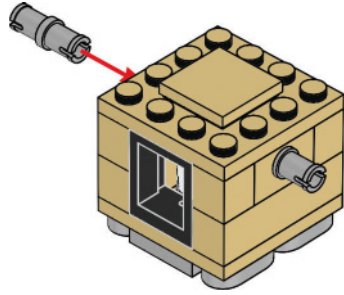

56

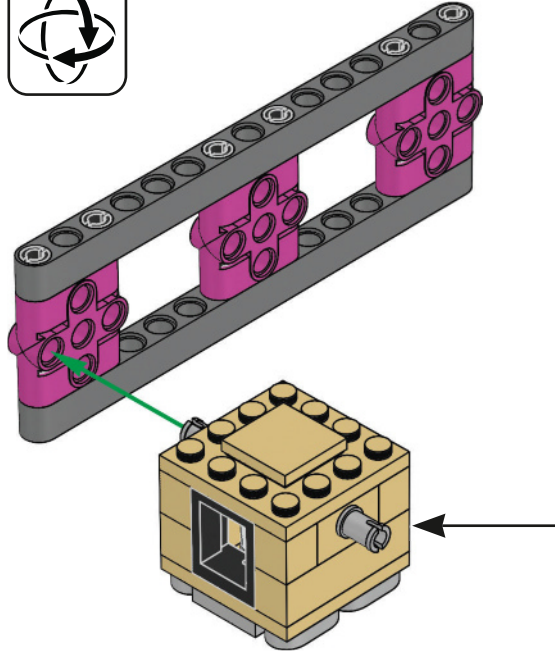

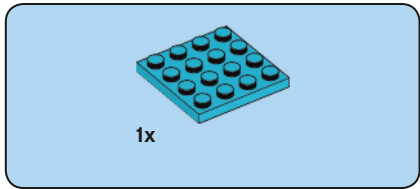
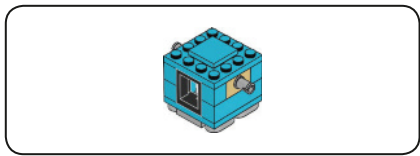

57

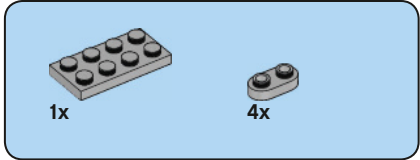
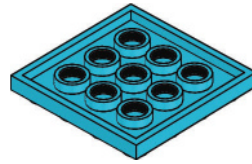

58

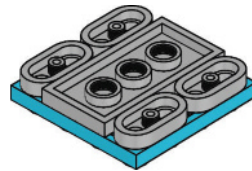

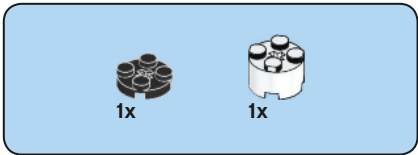

59

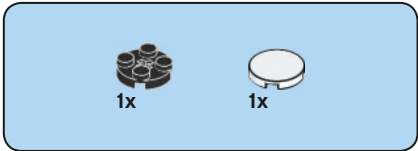
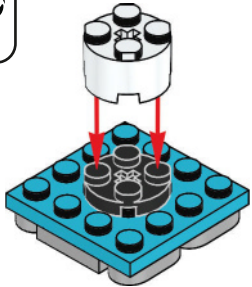

60

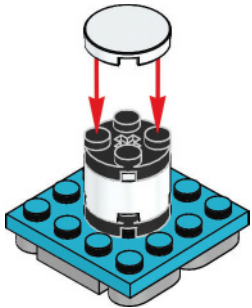

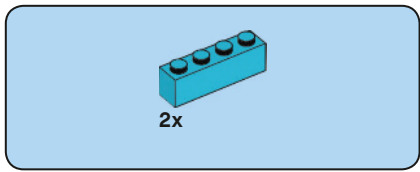

61

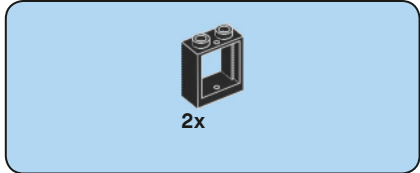
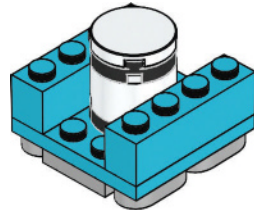

62

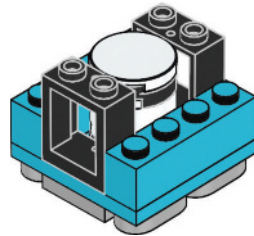





2x



4x

# 63

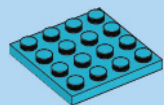
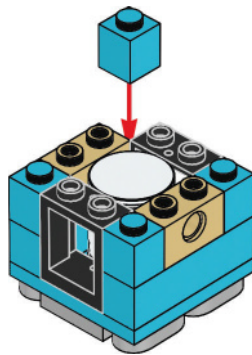

1x

# 64

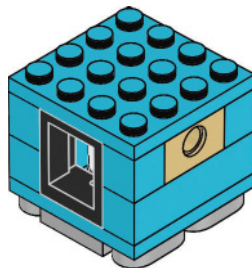

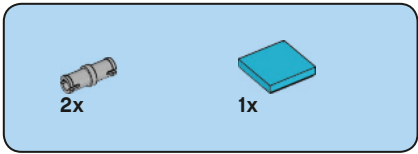

65

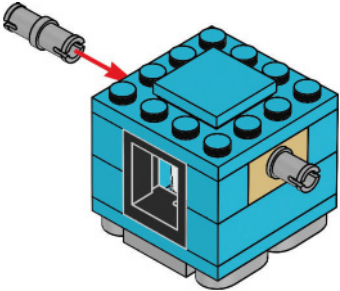

66

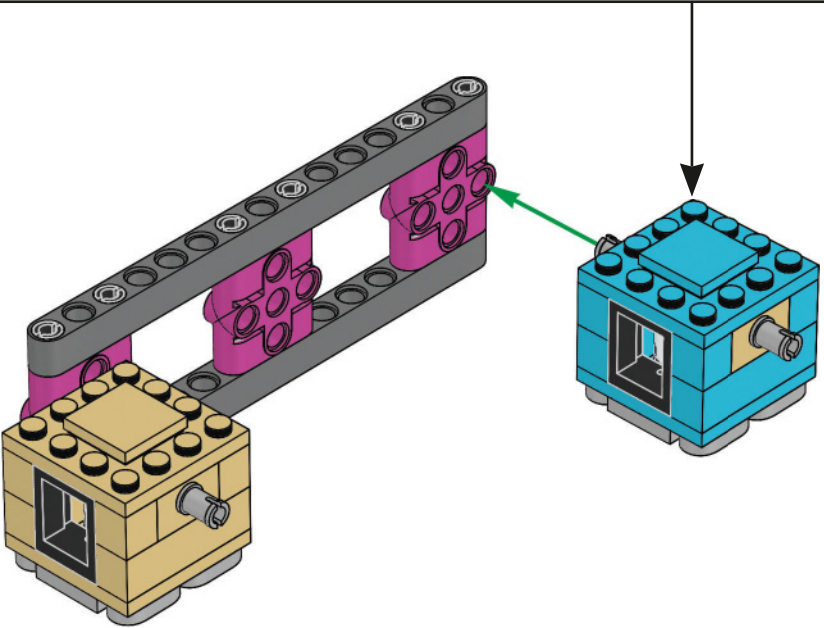

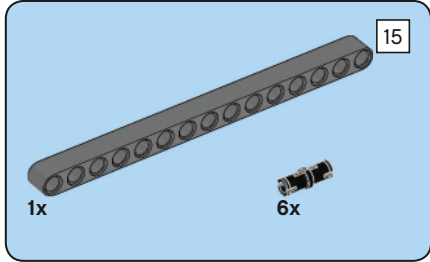
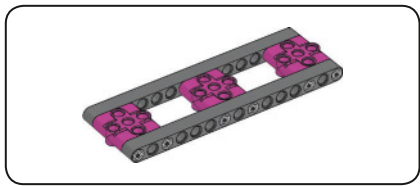

67

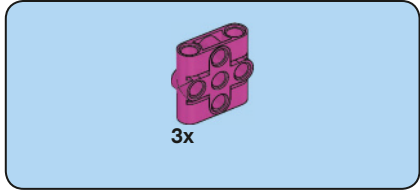
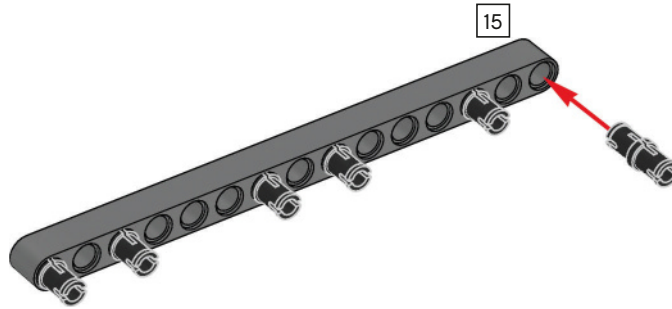

68

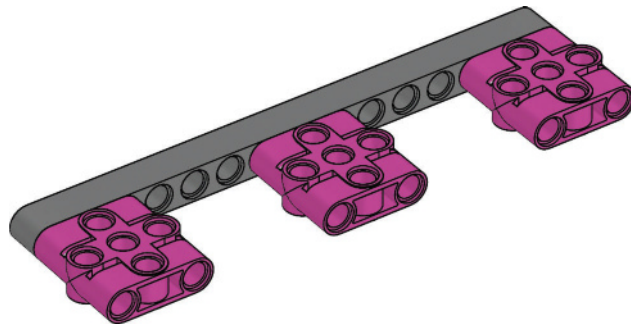



6x

69

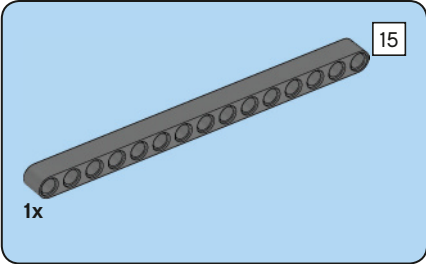
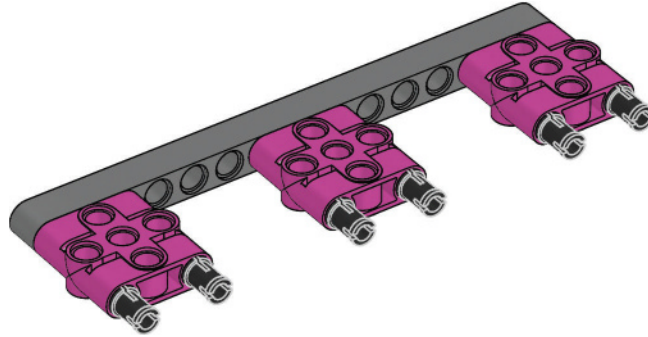

70

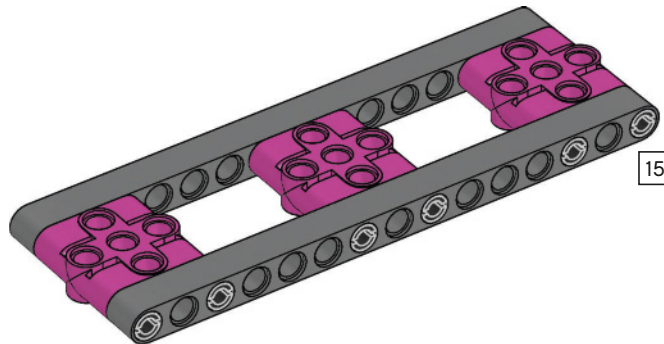

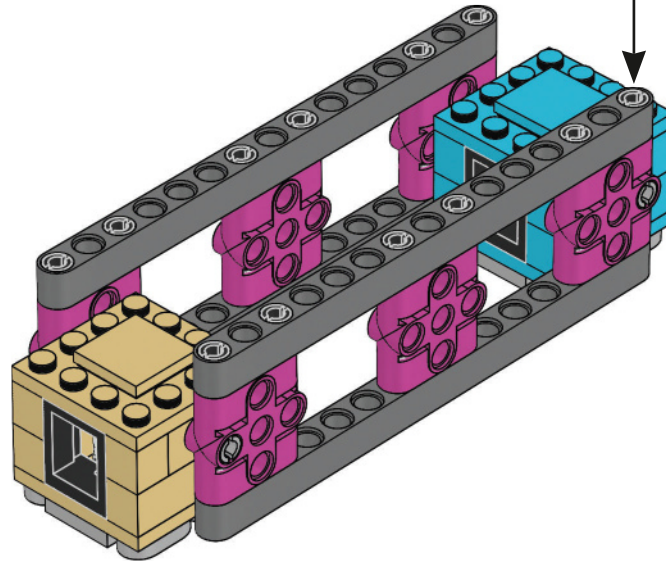



2x

72

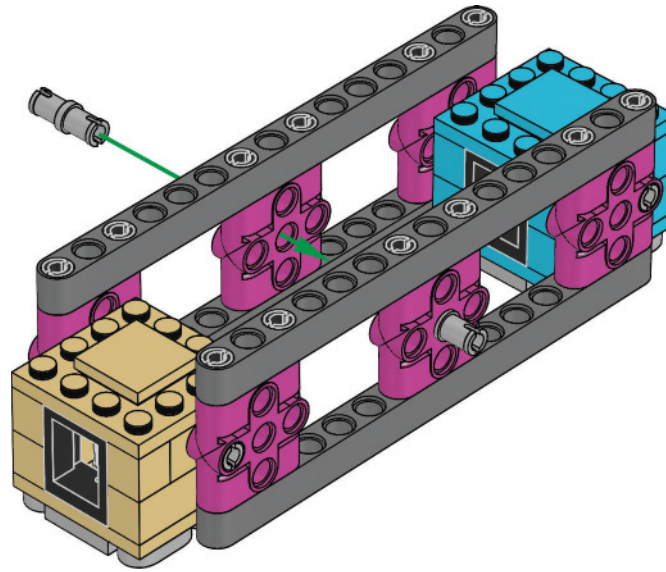

2x



2x

73

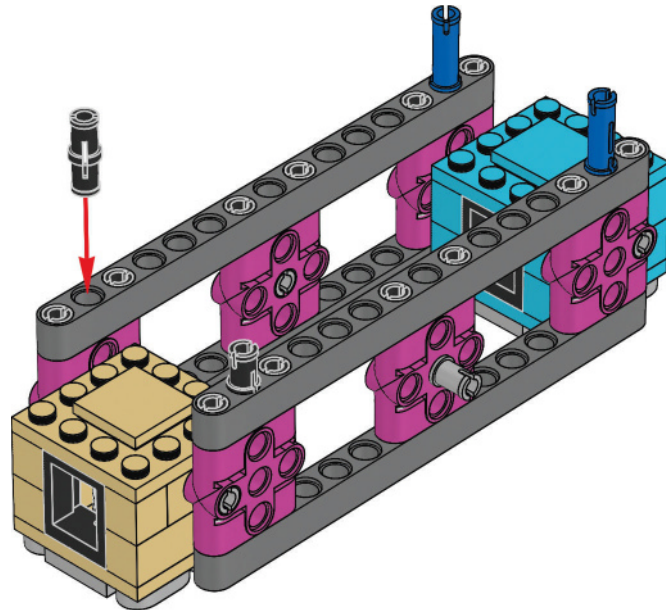

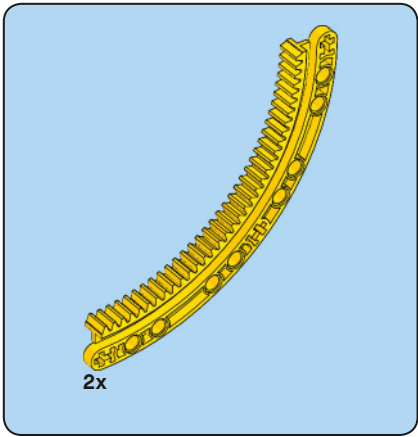

74

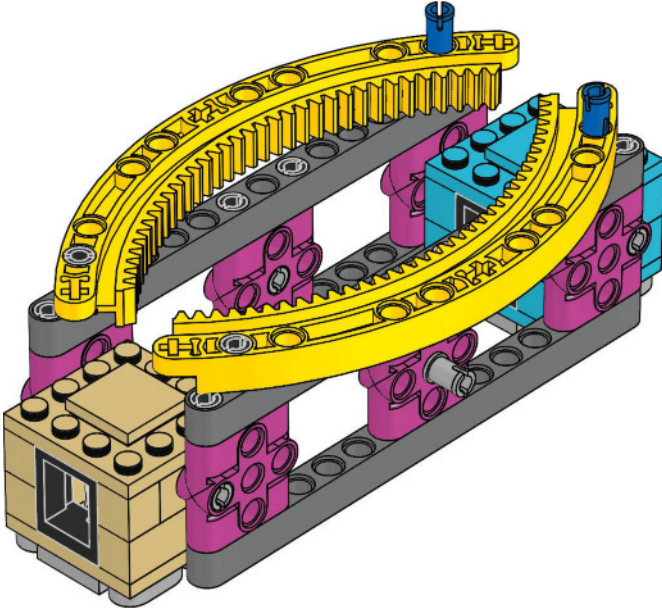

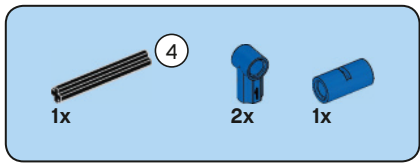

75

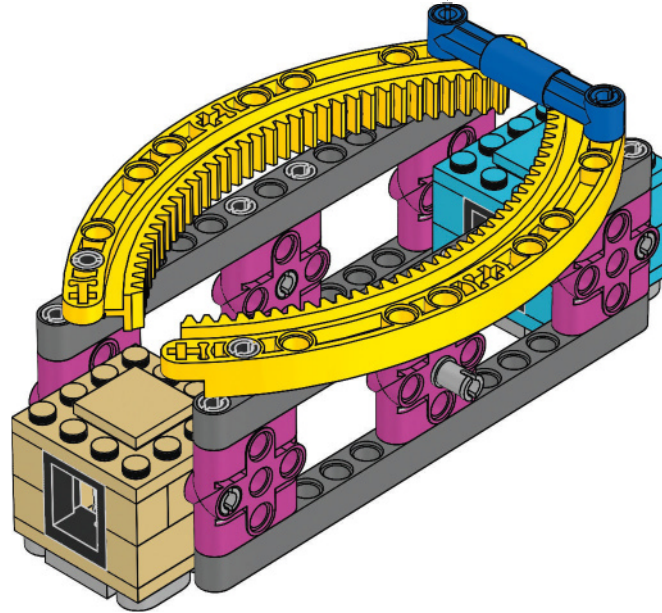
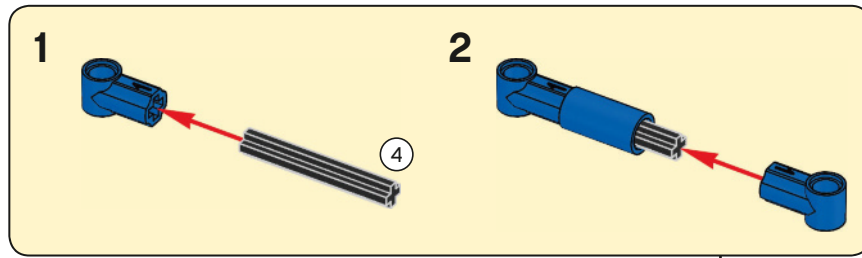



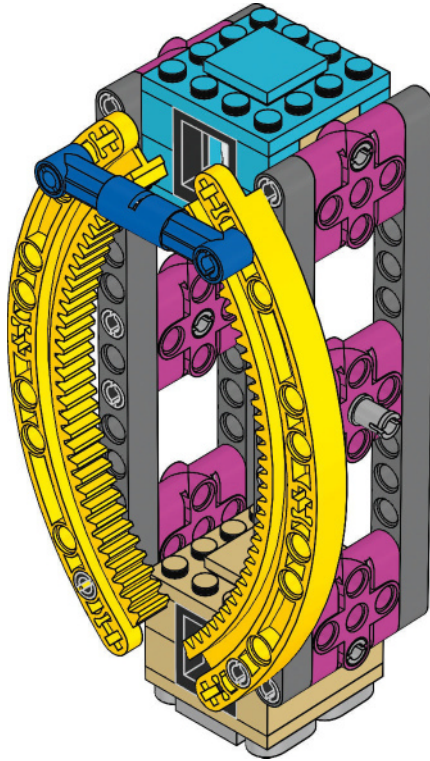

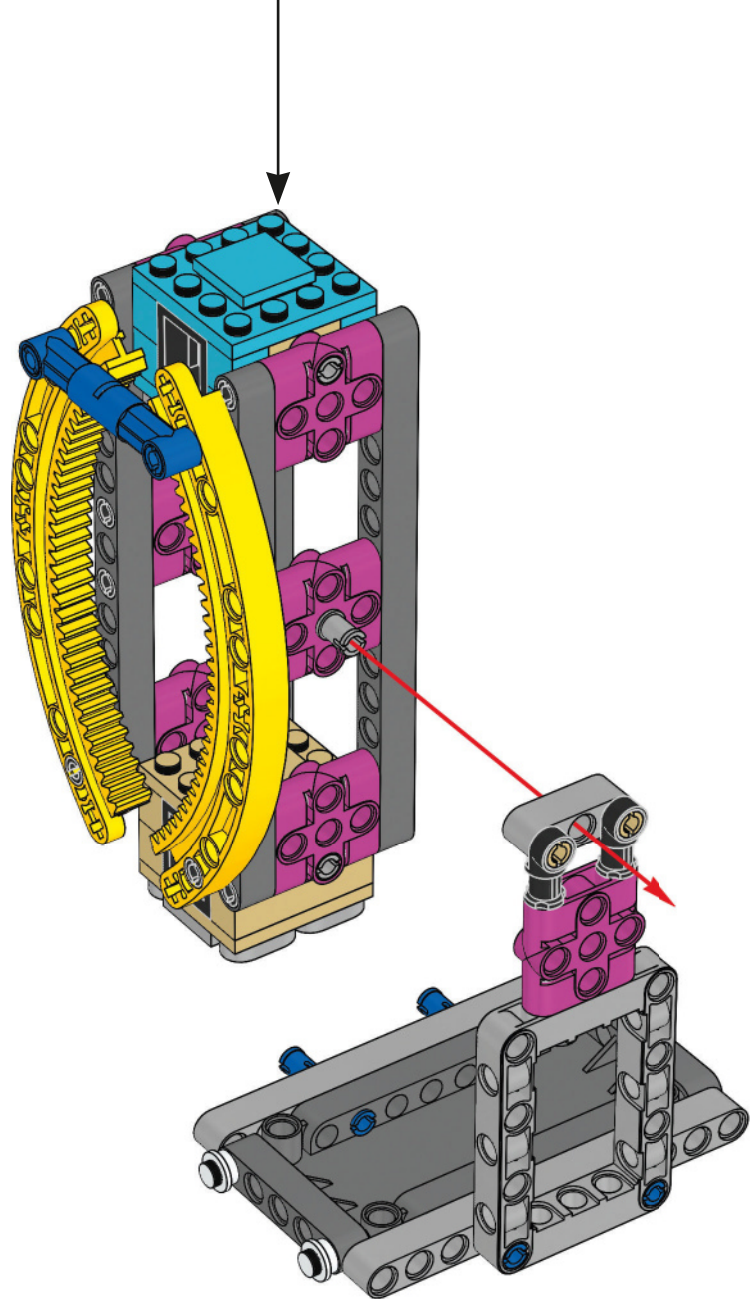

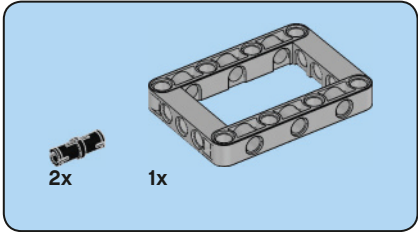
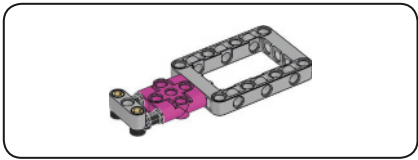

78

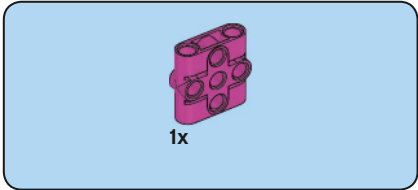
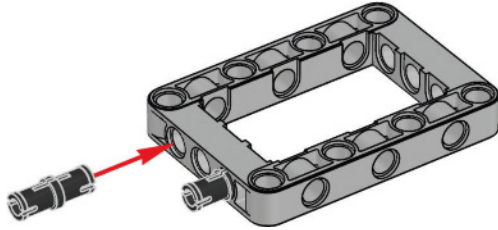

79

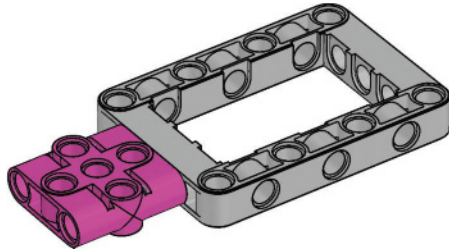

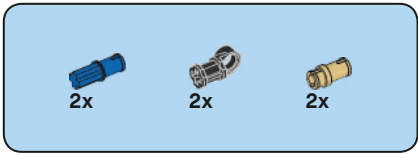

80

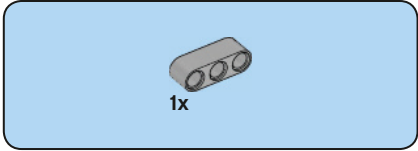
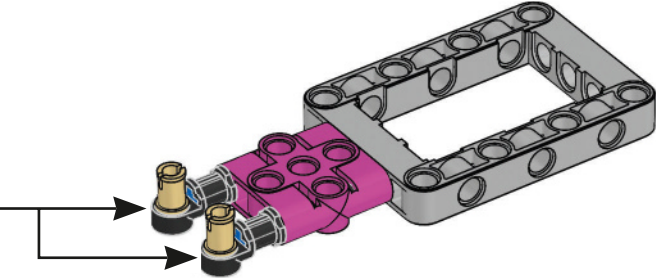
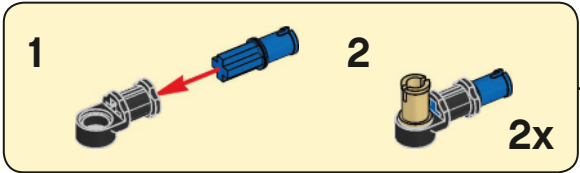

81

