

1

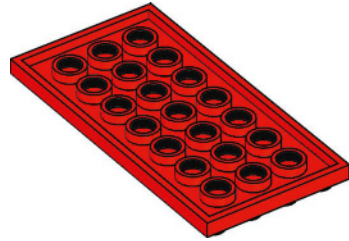

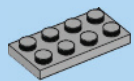

1x
Gris moyen



6x
Gris moyen

2

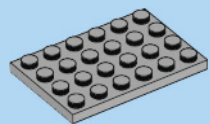
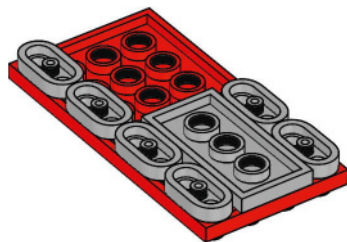

1x
Gris moyen

3

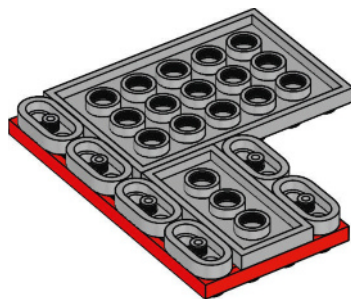

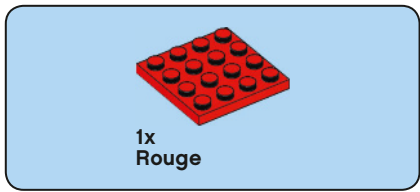

4

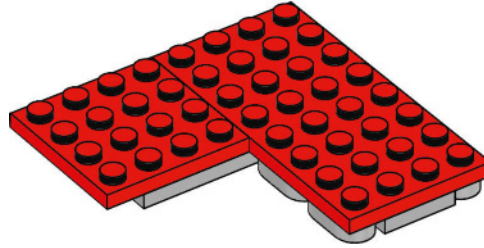

5

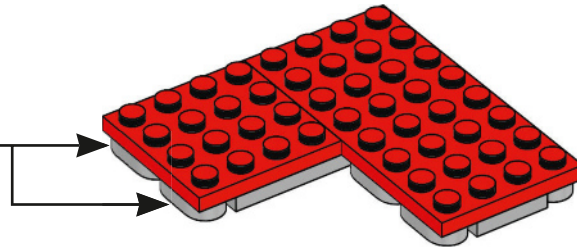

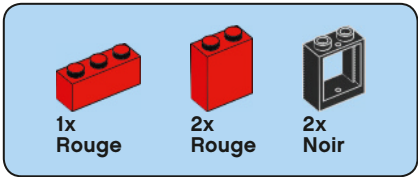

6

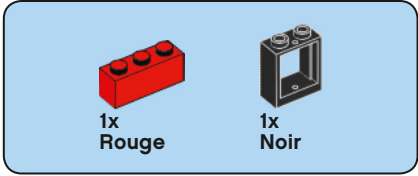
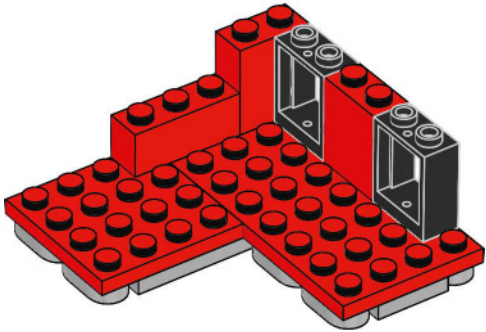

7

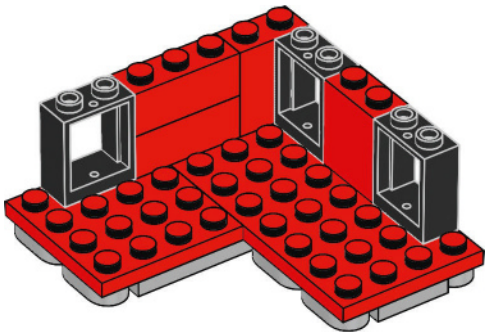

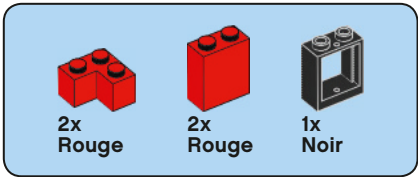

8

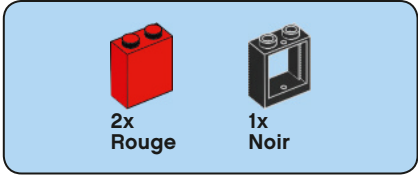
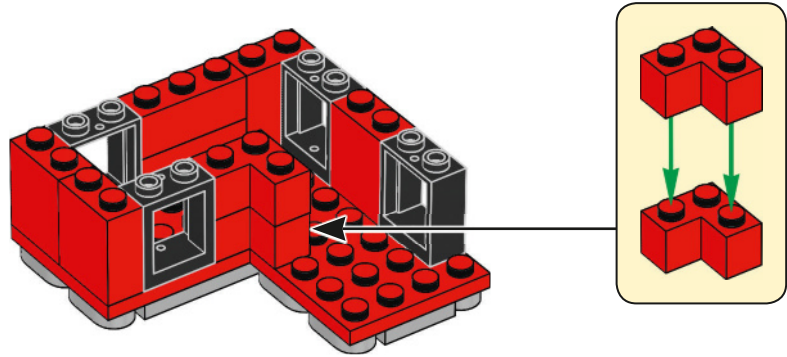

9

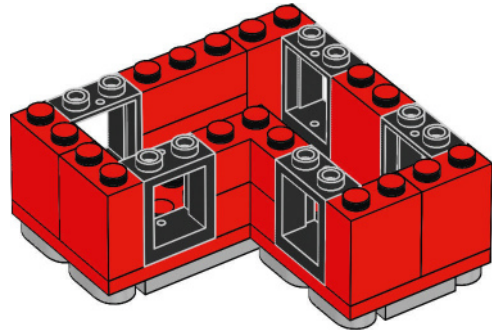

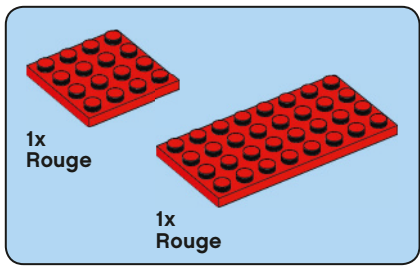

10

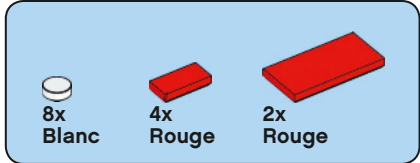
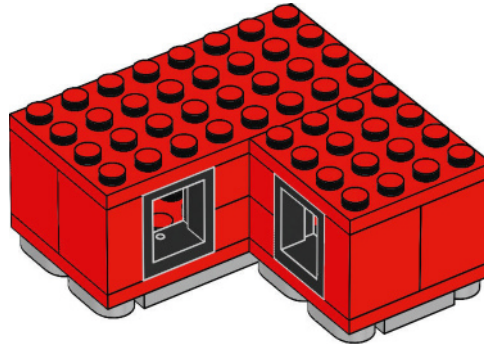

11

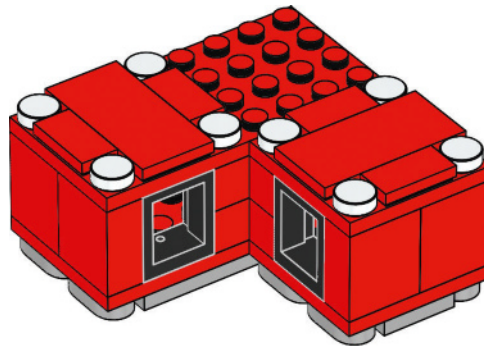



2x
Rouge

12

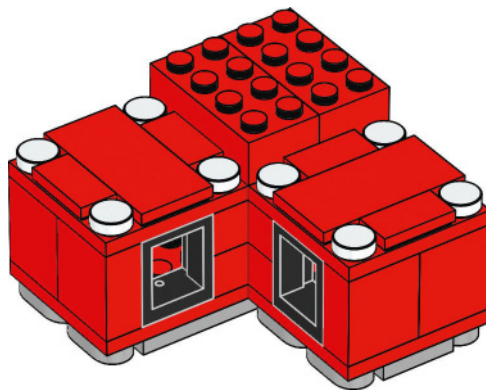

4x
Rouge



2x
Noir

13

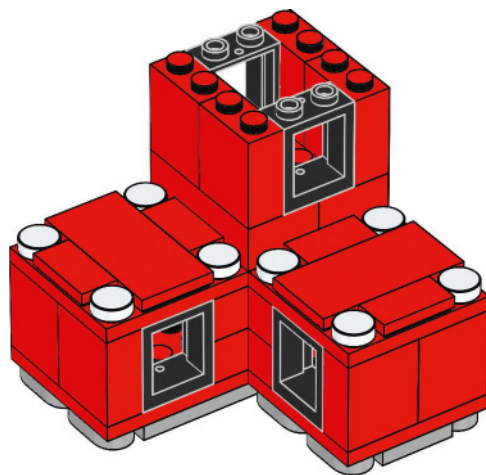

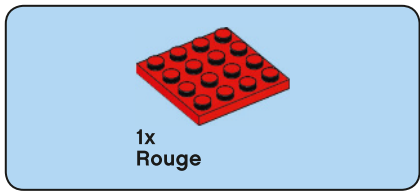

14

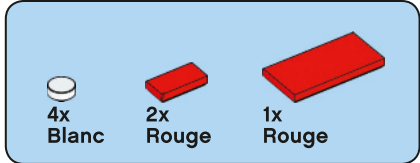
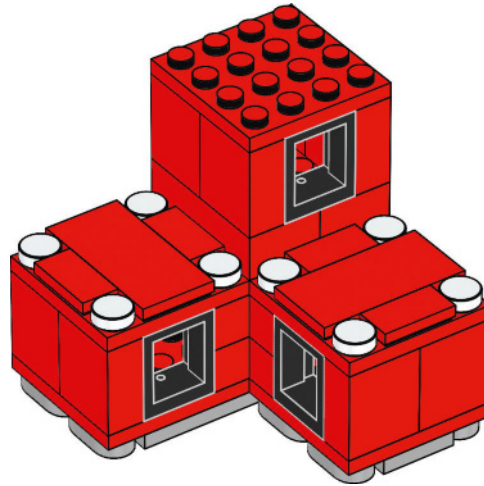

15

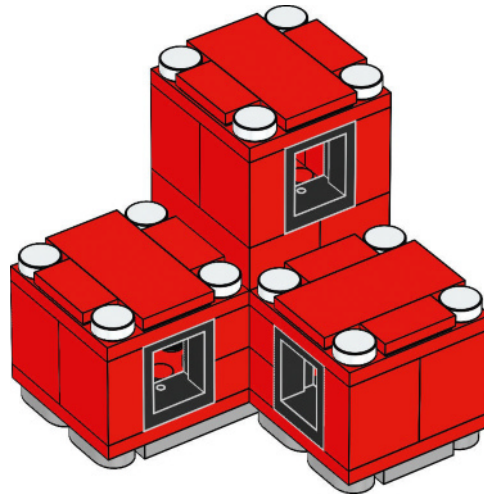

4x

SACHET 5

LEGO and the LEGO logo are trademarks of the/son des marques de commerce du/son marcas registradas de LEGO Group. ©2019 The LEGO Group. All rights reserved/Tous droits réservés/Todos los derechos reservados.

FIRST® is a registered trademark of For Inspiration and Recognition of Science and Technology (FIRST). LEGO® is a registered trademark of the LEGO Group. FIRST® LEGO® League and CITY SHAPER™ are jointly held trademarks of FIRST and the LEGO Group. ©2019 FIRST and the LEGO Group. All rights reserved.